



ROWE-ACKERMANN

F/2.2 SCHMIDT ASTROGRAPH

Big! Fast! Wide! Sharp!

The Story of the Rowe-Ackermann Schmidt Astrograph

By Richard Berry and the Celestron Engineering Team



Version 01, April 2016

Big! Fast! Wide! Sharp!

The Story of the Rowe-Ackermann Schmidt Astrograph

1. Introduction

Astronomers building the mighty 200-inch Hale telescope on Palomar Mountain took an unprecedented step. In addition to the giant telescope, they included two additional telescopes: wide-field survey telescopes. First on the mountain in 1936 was the 18-inch Schmidt camera. It was a radically different instrument: a sharp, wide-field camera designed to survey the sky. With a focal length of just 36 inches, it covered a field 8.75° diameter on a 6-inch “cookie” of photographic film. And its $f/2$ focal ratio meant that exposure times were short compared to any other telescope in the world.

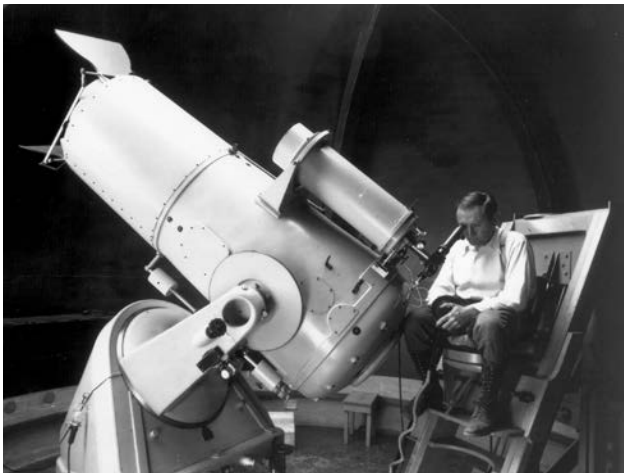

Fig. 1: Using the Palomar 18-inch Schmidt camera, the innovative astronomer Fritz Zwicky proved the value of high-étendue survey telescopes to the stodgier scientists of his day. Courtesy of the Archives, California Institute of Technology

Cal-Tech astronomer Fritz Zwicky promptly put the new Schmidt to work. Instead of zeroing in on tiny areas of the sky as astronomers had done traditionally, he mapped for the first time the full extent of clusters of galaxies, finding too little visible mass in the galaxies to hold the clusters together. Zwicky’s investigations were the first hints that the Universe is dominated by dark matter and dark energy rather than the ordinary matter of stars, galaxies, and people.

Impressed by the success of the 18-inch Schmidt giant, astronomers began construction of a larger Schmidt in 1938, but World War II intervened, so it was not until 1948 that the 48-inch Schmidt and the 200-inch Hale telescope began nightly work. Although the 200-inch had an enormous light grasp, its field of view was minuscule. With it, an astronomer could photograph a single galaxy, take a spectrum of a single star, or construct an H-R diagram for a single globular

cluster. Time on the 200-inch telescope was precious, tightly focused, doled out to a small, select cadre of astronomers.

In sharp contrast, the much smaller 48-inch “Big Schmidt” became, quite possibly, the most productive telescope on Earth. From 1949 until 1958, a sizable portion of the Schmidt’s dark-sky time was devoted to making the first comprehensive photographic survey of the sky in two colors. With an aperture of 48-inches and focal length of 120 inches, the Big Schmidt captured $6^\circ \times 6^\circ$ chunks of sky on 14-inch square glass plates. Each field was recorded in blue light and in red light, and after careful inspection, full-size photographic prints were distributed to subscribing observatories around the world. For a tiny fraction of the cost of a small professional telescope, the National Geographic Society-Palomar Observatory Sky Survey (or POSS for short) placed deep images of the entire northern sky at the fingertips of every working astronomer in the world.

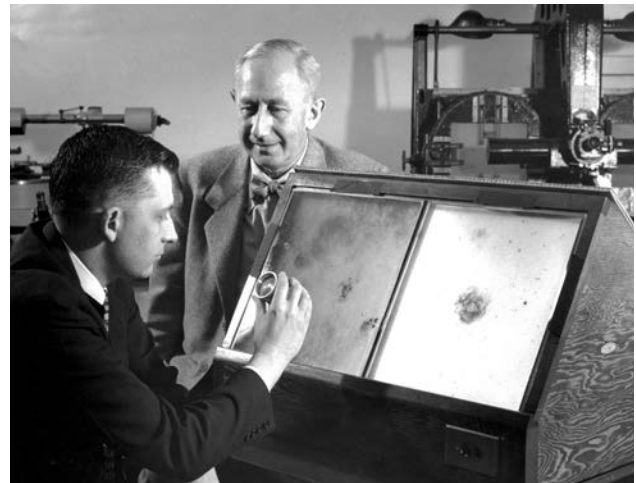

Fig. 2: The “Big Schmidt” served as a virtual finder telescope for an entire generation of astronomers. Its large glass plates were reproduced on paper and distributed to observatories around the world. Courtesy of the Archives, California Institute of Technology

Fast-forward to 1990. The Hubble Space Telescope is in orbit, CCDs have replaced photographic plates at ground based observatories, and computers are ready and waiting to handle Big Data. New large telescopes had been built or were under construction at observatories in the Andes, the Canaries, on Hawaii – and cosmology had become the driving force behind astronomical research. Cosmology required surveying the sky again and again in search of supernovae to tie down the cosmic distance scale and calibrate the rate

of expansion of the Universe. So too did the search for asteroids – their numbers building into the thousands and then tens of thousands – with their potential to deliver a civilization-ending impact. As did the need to monitor the growing number of artificial satellites and even faster-growing amount of space debris in orbit around the Earth. Comprehensive sky surveys provided the targets for the orbiting observatories and the great ground-based telescopes. What the world needed was a new generation of powerful wide-field survey telescopes, what the telescope designers and builders called telescopes with high étendue.

2. What is Étendue?

Among optical workers, étendue is a familiar concept: it is the energy flowing through an optical system. In a movie projector, for example, étendue is the product of the area of the lamp filament and the solid angle intercepted by the projector's condensing lenses. Because étendue is conserved in a system of lenses and mirrors, there is no way to increase the amount of light thrown on the movie screen by clever optical tricks; the only way to increase the light on the screen is a larger lamp filament or larger solid angle.

Although a telescope collects light rather than projects light, the principle is the same: the étendue is the product of the collecting area of the objective times the solid angle of light captured. The étendue, \mathcal{E} , is therefore:

$$\mathcal{E} = A\Omega$$

where A is the collecting area and Ω is the solid angle of the field of view. When evaluating the étendue of a large astronomical telescope, the collecting area is usually measured in square meters and the field of view in square degrees. Thus étendue is measured in units of m^2deg^2 . For example, a telescope with a collecting area of one square meter ($A = 1\text{m}^2$) that captures images that one degree on a side ($\Omega = 1\text{deg}^2$) has an étendue of $1.00 \text{m}^2\text{deg}^2$. The original 48-inch Schmidt had an étendue of $46 \text{m}^2\text{deg}^2$.

Étendue is a useful metric for survey-type telescopes because a large étendue requires that both the aperture and the field of view be large, or if one is small, the other must be very large. The hidden dimension in high-étendue telescopes is time: the time required to examine a tract of sky. The Palomar Observatory Sky Survey required exposing 936 pairs of plates (20 minutes for the blue plates and 40 minutes for the red) each covering a $6^\circ \times 6^\circ$ field of view – and took eight years to complete. If the Schmidt's aperture had been only 24 inches, reducing the area by a factor of four, the exposures could have been correspondingly lengthened, and the survey would have taken 32 years. To complete the survey with the same aperture but a $2^\circ \times 2^\circ$ field of view would have required 72 years (and

would still be in process today). In short, the speedy (for those days) completion of the POSS was the result of the high étendue of the 48-inch Schmidt.

Of course, telescopes can do more than survey the sky. Many and perhaps most telescopes have been designed to zero in on specific selected star, quasar, asteroid, comet, supernova, or galaxy to make detailed images, measure brightness, or obtain a spectrum. What matters is a large light collecting area and sharp images; the telescope's narrow focus does not matter to the astronomer. Astronomical advances often come from studying relatively faint, rare, unusual, or transient objects and events, and to find those objects or catch those events in progress, the lure of giant narrow-field telescopes was hard to resist. Not until the 21st Century was well under way did astronomers recognize and fully embrace the need for deep, comprehensive surveys with high-étendue telescopes.

3. The Era of High-Étendue Telescopes

"The Universe is so vast," thinks the astronomer, "and my telescope is so small." The job of the growing number of survey instruments is to inventory the contents of the solar system, our Galaxy, and the Universe. Asteroids in particular pose a potential danger to our planet.

Technical Note about Étendue

As presented in this white paper, we have defined the étendue, \mathcal{E} , of a system as:

$$\mathcal{E} = A\Omega$$

where A is the collecting area and Ω is the solid angle of the field of view. However, this formulation fails to account for the sensitivity of the image sensor and the angular resolution of the optics. To include these factors, we write:

$$\mathcal{E} = A\eta\Omega / d\Omega$$

where η is the quantum efficiency of the image sensor and $d\Omega$ is the solid angle of one resolution element on the sky. While η for the best photographic emulsions was only about 3%, modern CCDs have broadband quantum efficiencies around 80%. The product $A\eta$ is the effective collecting area of the system, while the fraction $\Omega / d\Omega$ is a measure of the total count of "spots" resolved on the sky by the telescope. To gather data rapidly, an astrograph needs a large collecting area over a large number of resolution elements.

For large survey telescopes, $d\Omega$ is often limited by seeing, while short-focus wide-angle optics like the RASA are likely limited by pixel size. The classic photographic surveys were limited by the graininess of the photographic emulsions in use at the time. When the relevant factors are taken into account, today's CCD-equipped Oschin Schmidt is at least 100 times more effective than it was in the days of pre-digital photography.

Well over 250,000 are currently known, and still more that are 100 meters or more in diameter – civilization killers – have yet to be found. Among stars, it’s those with planets that hold particular interest. These systems are to be found by watching millions of stars for the few telltale hours when a planet blocks a tiny bit of starlight. To gauge the expansion of the Universe, astronomers patrol for rare supernova explosions that serve as “standard candles” for calibrating distance and cosmic expansion.

To spy out such elusive quarries, a telescope must have a large aperture to see faint objects, a short focal length to match the pixels on a CCD sensor, and it must produce sharp images over a wide field of view: in short, it must have high étendue. Table 1 lists a sample of current and soon-to-be-implemented sky surveys. Perusing this list we find the 48-inch Oschin Schmidt soon to be equipped with the massive Zwicky Transient Factory camera with sixteen 36-megapixel CCDs covering a total of 47 square degrees. Although the Oschin Schmidt is one of the smaller instruments, its wide field coverage means that every night it snaps hundreds of deep images that are searched immediately by computer for “transients” – that is, anything that’s changed since the previous night.

Even more powerful is the LSST – the Large Synoptic Survey Telescope – now under construction in Chilean Andes. With an 8.4-meter primary mirror and covering a field of view 3.5 degrees across (9.6 square degrees) and a camera with 189 16-megapixel CCDs for a total of 3.2 gigapixels per exposure. At each sky location, the LSST will make two 15-second exposures, and then it will move on. Each night it will produce 30 terabytes of data that will be processed immediately and made available to the world.

Table 1: Wide-Field Sky Surveys

| Survey Telescope | Effective Aperture (meters) | Ω (deg ²) | Étendue $A\Omega$ (m ² deg ²) |
|-------------------------------------|-----------------------------|------------------------------|--|
| USAF Linear | 1.0 | 2.0 | 1.5 |
| Catalina Schmidt | .68 | 9 | 3.6 |
| Sloan Digital Sky Survey | 2.5 | 3.9 | 6.0 |
| CFHT Megacam | 3.6 | 1 | 8.0 |
| SUBARU-SuprimeCam | 8.1 | 0.2 | 8.8 |
| ATLAS Project | 1.0 | 54 | 42 |
| Oschin-ZTF | 1.2 | 47 | 56 |
| Pan-STARRS | 3.7 | 7 | 60 |
| LINEAR Space Surveillance Telescope | 3.5 | 6 | 70 |
| Large Synoptic Survey Telescope | 6.5 | 9.6 | 319 |

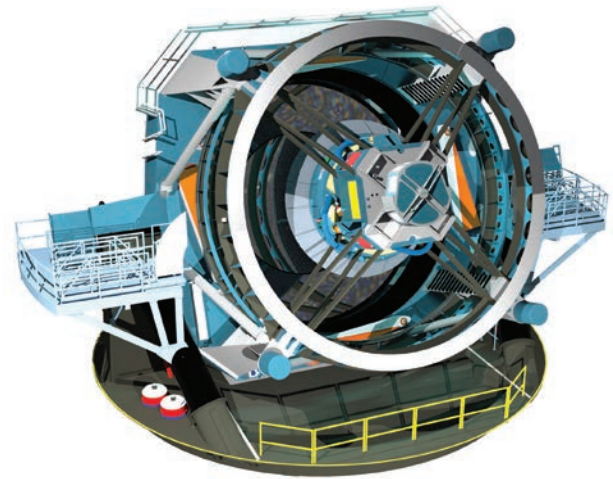

Fig. 3: When the 8.4-meter LSST goes online, it will survey the entire sky twice a week over and over again, turning up thousands of potentially interesting objects every night it operates.

4. Richest-Field Telescopes: Étendue for the Amateur Astronomer

Scouring the sky for elusive objects has long been one of the preoccupations of the astronomical amateur, tyro and expert alike. Charles Messier, that tireless 18th Century seeker of comets, found 13 comets and more than a hundred faint, non-cometary glows in the heavens, the “Messier objects” we know now as galaxies, star clusters, and nebulae. Caroline Herschel, sister of the astronomer William Herschel, and an astronomer in her own right, found at least seven comets using a special short-focus, low-power telescope known as a “comet seeker.” Comet seekers, or “richest-field telescopes”, are the visual observer’s equivalent of the high-étendue astrograph. They combine a short focal length, large objective, and low-power eyepiece to deliver the highest concentration of light to the retina of the observer’s eye. This enables the seeker of comets to survey many fields quickly by sweeping the sky looking for the out-of-place, slow-moving fuzz-ball.

The 19th Century ushered in the search for asteroids. On Jan 1, 1801, Giuseppe Piazzi spotted asteroid (1) Ceres, triggering a race among both amateurs and professionals to find more “minor planets” orbiting between Mars and Jupiter. In 1891, professional astronomer Max Wolf began photographic searches for comets, asteroids, novae, and whatever else was new in the sky using a 16-inch f/5 astrographic reflector that had, for its time, a remarkably high étendue. His efficient searches and surveys churned up stars with high proper motion, supernovae, dark nebulae, and many faint emission nebulae, leaving the amateur asteroid-seekers far behind.

As astronomy grew as hobby, however, the easy-to-use Schmidt-Cassegrain dominated astro-imaging despite a low étendue. The classic SCT had a slow f/10

focal ratio and small field of view. For visual observers, however, the Dobsonian revolution ushered in an era of high étendue deep-sky exploration. With apertures starting around 12 inches extending upward of 36 inches combined with focal ratios of $f/4$ to $f/5$ and short-focus low-power wide-field eyepieces, the visual observers searched out and viewed many previously difficult deep-sky objects. The visual deep-sky-revolution inspired, in turn, renewed interest in deep-sky imaging, and the introduction of new high étendue astrographs for amateur astronomy.

5. Celestron's Schmidt, Fastar, and HyperStar

The value of Schmidt cameras had long been evident to amateur as well as professional astronomers. In the 1970s, Celestron introduced two Schmidt cameras for use with 35mm photographic film. The first had an aperture of 5.25 inches and a focal ratio of $f/1.65$, and the second an aperture of 8 inches with a focal ratio of $f/1.5$. In the 8-inch version, each exposure covered a $4.5^\circ \times 6.5^\circ$ field of view. At these very short focal ratios, deep-sky images could be captured on fine-grain films in a mere 30 minutes! These cameras took advantage of Celestron's ability to manufacture the tricky Schmidt corrector plate at an affordable price. In a Schmidt camera, the focal surface is curved and the images are formed inside the tube halfway between the corrector plate and the primary mirror. A special film holder that gently bent the film to the correct curvature was suspended on spider at the proper location. Although cutting, inserting, and developing small "chips" of film had to be performed in complete darkness, more than a few amateurs became proficient in these manipulations, taking splendid wide-field deep-sky images on super-fine-grain film known as Kodak Tech Pan.



Fig. 5: Celestron's 8-inch $f/1.5$ Schmidt camera gave amateurs access to fast, sharp, wide-field astrophotography on Kodak's remarkable Tech-Pan film. Photo by Kent Kirkley.

In the amateur world, in the 1990s, as film gave way to smaller but more sensitive CCDs, Celestron introduced another forward-looking product: the Fastar camera. The Fastar was a hybrid instrument created by removing the secondary mirror from a standard C8 Schmidt-Cassegrain and replacing it with a system of lenses mounted on the corrector plate. Celestron's image sensor was a CCD camera: the PixCel 255. By 1999, the original PixCel was obsolete, and replaced by SBIG's ST-237 CCD camera. With a focal ratio of $f/2$, the Fastar system was as fast as a Schmidt camera, allowing amateurs to reach sky-limited exposures in just a few minutes. But the CCDs of the day were very small: the PixCel 255 had a 320×240 pixel array, and the ST-237 had a 640×480 array measuring 4.7×3.6 mm and covering a field 40×30 arcminutes on the sky (this was considered "wide-field" in its time).



Fig. 6: The 8-inch $f/2$ Fastar carried a PixCel CCD camera ahead of the corrector plate. In a fast telescope, it turns out that the best place for a compact image sensor is at the prime focus.

When Celestron discontinued the Fastar, they did not abandon the idea of a wide-field camera at the prime focus of their Schmidt-Cassegrain. Celestron continued to make SCTs with removable secondary-mirror assemblies, and they passed the baton to the Starizona HyperStar. Unlike the small-sensor Fastar, the HyperStar was designed to cover a fairly sizable 27mm diameter field found in APS-C digital SLR cameras at a focal ratio near $f/2$ on HyperStar-compatible C6, C8, C9.25, C11, and C14 SCTs. Starizona provides conversion kits for non-HyperStar SCTs and camera adapters for a wide variety of CCDs and DSLR cameras.



Fig. 7: The Starizona HyperStar worked extremely well with APS-C DSLR cameras. By combining fast optics, short focal length, and wide field, it paved the way for the Rowe-Ackermann Schmidt Astrograph.

Although the Fastar was first, it fell to the HyperStar to introduce fast, wide-field imaging to amateur astronomy. In the decade since its introduction, the Hyperstar carved a niche for short-exposure wide-angle, deep-sky imaging. But the HyperStar was an add-on component rather than a fully integrated part of the system. Forced to meet constraints imposed by a pre-existing corrector plate, primary mirror, component spacing, hole diameters, and mounting points, it was a necessary compromise solution. Would a dedicated optical design provide bigger fields, sharper stars, less vignetting, and greater mechanical stability?

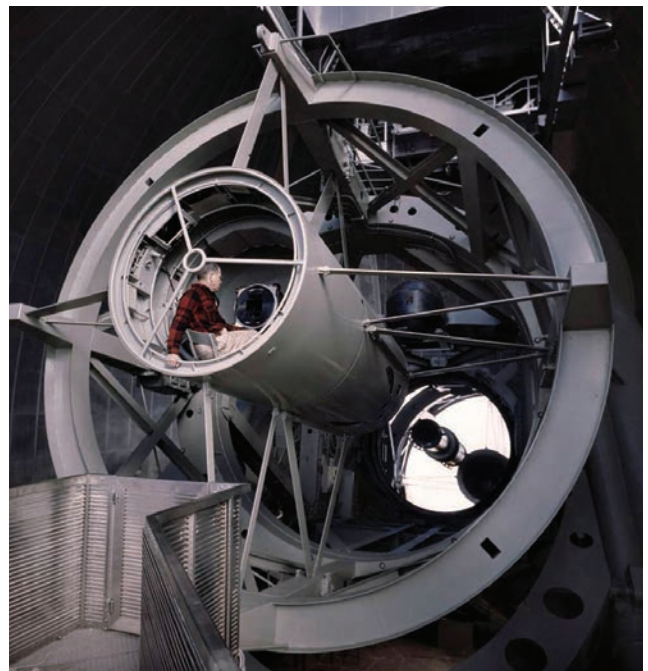

Fig. 8: Back in the days of the Hale 5-meter telescope, the observer photographed the sky from the prime focus. Today, on amateur astronomers' telescopes, a CCD camera occupies prime focus. Photo: LIFE

6. The RASA Is Conceived

The name of the Rowe-Ackermann astrograph acknowledges David Rowe and Mark Ackermann, the two astronomer/inventors who conceived and refined its optical design. Back in 2012, Rowe had been consulting for Celestron, so he had met regularly with Celestron's product gurus. "I told them I thought they should offer a telescope like a Schmidt camera with a flat focal surface," Dave says, "but I felt that it absolutely had to have the image outside the telescope tube."

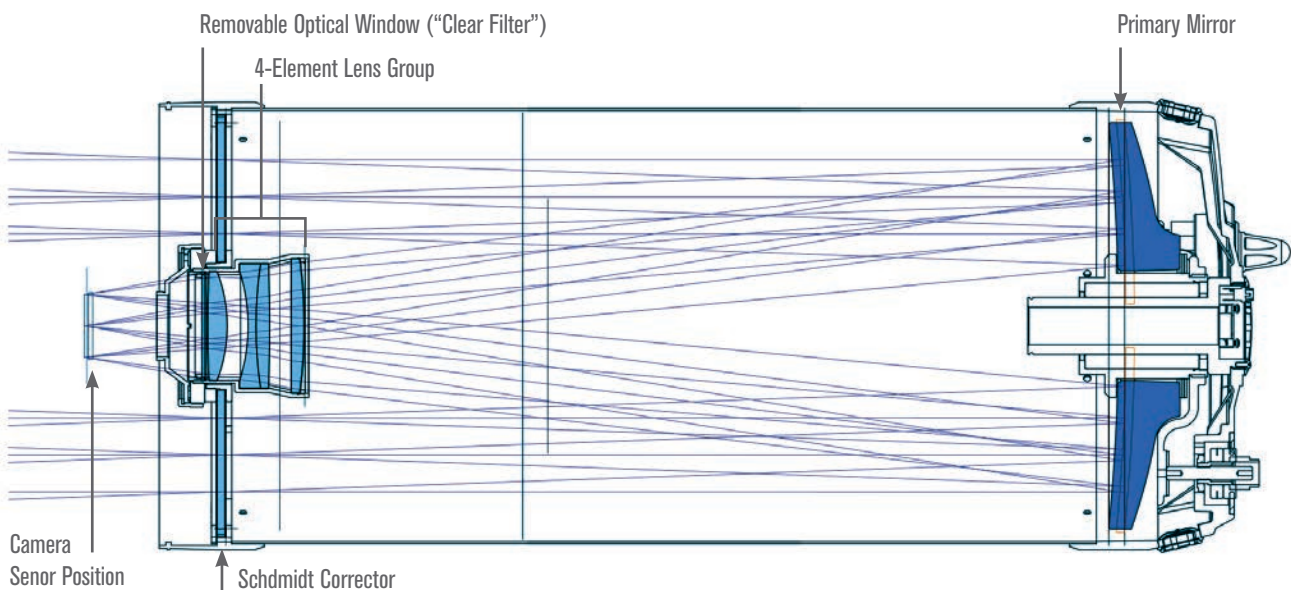

Fig. 9: Celestron's Rowe-Ackermann Schmidt Astrograph consists of a Schmidt correcting plate, primary mirror, and a four-element corrector lens. Light enters from the left, passes through the corrector plate to the primary mirror, then reflects back through the corrector lens and comes to focus in front of the corrector lens.

Matrix Spot Diagram (9 μm box size)

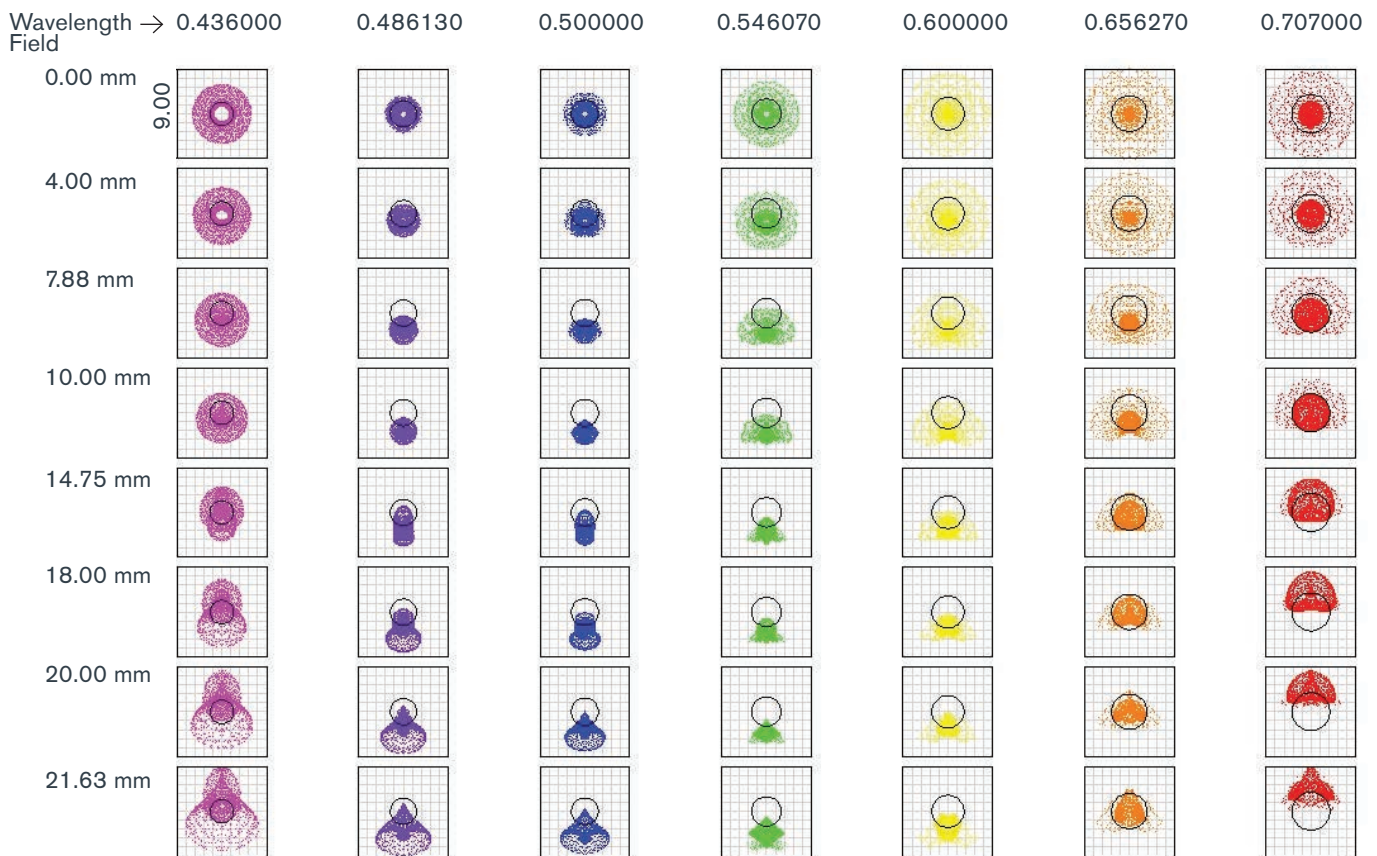

Fig. 10: The RASA's matrix spot diagram reveals that it forms remarkably tight star images across the entire visible spectrum from deep violet (0.43μ) to near infrared (0.70μ), from the center of the field to more than 21mm off axis. In practice, a field of view 52mm diameter is practical. The boxes are 9 microns on a side.

In the classic Schmidt camera, the image is formed inside the tube halfway between the corrector plate and the primary mirror. "There are all sorts of problems putting a CCD camera inside a closed tube, and with most DSLRs it would not work. Although a diagonal mirror like a Newtonian's diagonal sounds like a good idea, it's just not practical. The Schmidt is so fast that the diagonal has to be huge, and it blocks way too much light."

Rowe fired up his computer and started kicking around ideas. Placing a two-element correcting lens just ahead of focus would flatten the curved field of the classic Schmidt camera, but the focus was inside the tube. By placing the focus in front of the corrector plate, as the Hyperstar did, the focus fell outside the tube. "I discussed it with Corey Lee, Eric Kopit, and Dan Medley at Celestron, and we all felt that an 8-inch astrograph was too small for a DSLR. The camera body would block too much light. The design had to be based on standard 11-inch SCT optics." Rowe went back to his computer and began tracing rays through the optics in search of a good solution.

A month later, he had a design consisting of a Schmidt corrector plate, a spherical mirror, and a three-element correcting lens with the focus in front of the corrector plate. To get the best performance, however, the design required a corrector plate with more optical power. "Celestron did not want to change the corrector," Rowe noted, "because they mass-produce corrector plates that are perfect for their SCTs. Instead, they suggested I should see what I could do with their C-11's standard corrector plate and a different spherical mirror." A mirror with a longer radius of curvature would be straightforward to produce using the same glass blanks as the regular C11 SCT. Retaining the standard corrector plate would keep the cost to the consumer down and also guarantee excellent optical quality.

"So I worked up a new design that used a longer primary mirror, the standard C11 corrector plate, with a three-element correcting lens using common glass types. It produced a well-corrected 43mm field at f/2.2 with a 55mm back focus distance compatible with DSLR cameras, and I left it at that." A year later,

Dave walked into Celestron's offices to find they had a working prototype of the RASA!

Unknown to Dave, Celestron had asked Mark Ackermann (Sandia National Laboratories, University of New Mexico) to look over the design. "It was Dave's idea," said Mark, "and when Celestron asked me to design a production version, I took on the project." An amateur astronomer by night, by day Mark is an expert on space surveillance systems. Used to thinking about apertures measured in meters, Mark was intrigued by Dave's small-aperture high étendue design: it might turn out to be ideal for surveilling space debris and fast-moving satellites in LEO (low Earth orbit), tasks best accomplished by large numbers of small telescopes.

"I pushed the design outside the original box," he mused, "I optimized it to cover a wider spectral range – the whole visible spectrum from 400 nm to 700 nm – and specified that the correcting lens have four elements rather than three, and I employed special low-dispersion optical glass for sharper star images. For a small increase in the cost of manufacture, we got star images smaller than 4.5 microns RMS. everywhere in a field 43.3mm across." In addition, Ackermann increased the diameters of the optical elements to reduce internal vignetting. "It's a university-quality system," he said, "a system with lots of capability at a very attractive price point."

7. How the RASA Works

The RASA is a modification of the Schmidt camera, the optical system in the pioneering 18-inch and Oschin Schmidt cameras, adapted to modern high-sensitivity CCD sensors. Schmidt cameras are based on an optical property of spherical mirrors: that light passing through the center of curvature of the mirror forms an equally good image regardless of the direction of the incoming light. This means that spherical mirrors can form images over a wide field of view, but spherical mirrors do not bring incoming rays from a given direction to a perfect image. The Estonian optician Barnard Schmidt realized, however, that by placing a thin lens at the center of curvature, he could "tweak" the incoming rays to converge to make an excellent image.

Schmidt's thin lens, the "Schmidt corrector plate," is a weak positive lens in the center and a weak negative lens at the edges. Schmidt not only recognized the principle, but he also worked out a way to grind and polish the glass surface of the lens to a polynomial curve. The spherical mirror formed its images inside the tube halfway between the corrector plate and the spherical mirror, and a photographic film held at that location captured the image. A decade later, the Schmidt camera had begun to revolutionize observational astronomy.



Fig. 11: The Schmidt corrector plate is not a simple optical window, it is actually an aspheric lens. Celestron's founder, Tom Johnson, revolutionized the manufacture of this optical element with his patented process, and the Schmidt corrector in the RASA is made in this same way.

As the 21st century began, film became obsolete. It was either inconvenient or impossible to support the bulky electronic package around the CCD sensor inside the tube. As Dave Rowe had recognized, the best place to put the camera was at the front of the optical tube. With careful design, the camera would block very little light, and optically, at least, it was the best design solution.

When the RASA is pointed at the sky, light rays from each star arrive traveling in parallel paths. As they pass through the Schmidt corrector plate, the rays receive a small refractive tweak so that after they have been reflected from the spherical primary mirror, they converge to focus to a star image. As the rays approach focus, they pass through the four-element lens assembly. On-axis rays are barely affected, while off-axis rays are refracted slightly to form tight, clean star images. By design, the RASA's star images are formed on a plane surface ahead of the RASA, where the image sensor is located. The sensor captures and stores the photoelectrons generated by each star's light until, at the end of the exposure, they are read out, converted to a digital signal, and transferred to your computer.

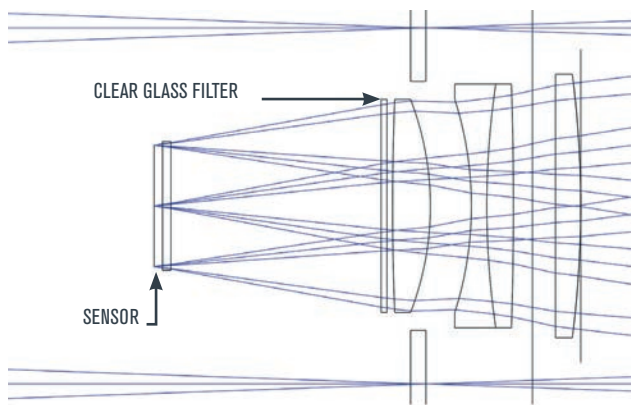

Fig. 12: This geometric ray trace shows how light from the RASA's correcting lens travels to focus on the sensor. Note that any obstruction in the space between the clear glass filter and the sensor blocks light and results in vignetting.

8. The RASA is Born: Manufacturing a Breakthrough Product

To bring out the RASA as a practical instrument for the amateur market, Celestron's optical and mechanical engineers faced some tough challenges. Although broadly similar to the Celestron Fastar models, the RASA had significant differences. The radius of curvature of the primary mirror was longer than that of a standard SCT. The tube would therefore be longer. Although the corrector plate was the same as the standard Celestron SCT, it was required to support a hefty four-element correcting lens assembly inside the tube, and outside the tube it needed a mounting for the adapter that would hold a DSLR or CCD camera. The fast focal ratio also meant that the depth of focus was just a few microns (thousandths of millimeter) lest the optical system's potentially pinpoint star images appear out of focus.

"We worried a bit about supporting the weight of the correcting lens and a CCD camera on the corrector plate," said Eric Kopit, Celestron's Director of Product Development, "so we did a test. We set up a corrector plate and hung heavier and heavier weights on it." The corrector plate finally failed when it had been loaded with 80 pounds. "After that," he said, "we did not worry."

"We improved the primary mirror focusing system by improving tolerances and using different materials," said Kopit. "The new system works on the same principles as that in the EdgeHD tubes" he said, "but because we didn't need a hollow Cassegrain baffle tube, we could use a tube with thicker walls, which permits a more consistent fit tolerance." Also, the surface which the primary mirror "slider" moves on is brass, rather than aluminum, which provides a smoother bearing.

The RASA is focused by moving the primary mirror. Instead of using the standard focus knob, Celestron added the Starlight Instruments Feather Touch focuser. This focuser provides both coarse and fine focus (1:10) adjustments, which is convenient when manually



Fig. 13: The Feather Touch focuser is included as standard equipment on the RASA 11-inch.

focusing. Kopit pointed out that not only was the Feather Touch an excellent off-the-shelf unit, but also the Feather Touch can be motorized with a proven off-the-shelf system, allowing observers to focus the RASA remotely. "In many search-based observing programs," he noted, "a RASA would be in use all night, every night, so remote focusing capability is not a luxury, but really a necessity."

For best performance, cooling optics inside the optical tube is also a necessity. Kopit explained, "Putting a cooling fan in the Cassegrain location at the base of the tube made a lot of sense. The fan pulls air down the tube so it flows around the primary mirror. We reengineered the vent mesh to optimize airflow." During an observing session, the fan would normally be run continuously so the tube and optics are always in equilibrium with the ambient air.



Fig. 14: The 12VDC MagLev fan along with improved venting allows for good airflow within the optical tube. This helps cool the telescope to ambient temperature.

Manufacturing the optical system was also a new experience for Celestron. "In our standard and EdgeHD SCTs, we make the corrector plates and primary mirrors as accurately as possible, but there are always slight variations. So we set up the primary and corrector plate in a test stand and hand-figure the secondary mirror to attain diffraction-limited imagery," explained Kopit. "The RASA is a different ballgame. We test the primary mirror



Fig. 15: All RASA primary mirrors are tested on an optical bench by means of laser interferometry. In the picture, stacks of polished primary mirrors await testing.

with an interferometer, so it is bang on. We test each of the eight surfaces in the correcting lens assembly using match plates, so they are well within a tight tolerance.” With everything meeting tight tolerances, there’s nothing left to match. “The RASA uses the same Schmidt corrector plate as the EdgeHD, but the EdgeHD corrector plates are hand-matched in the finished telescope by making small corrections to the secondary mirror. Because the RASA does not have a secondary mirror, the RASA design cannot be matched in this way. Instead, we set aside those

Schmidt corrector plates that our testing shows will give the best performance in the RASA,” he said. In this respect, manufacturing the RASA is more like manufacturing a high-quality camera lens than making a telescope: because each component meets tight specifications, hand matching becomes unnecessary.

The housing for the correcting lens assembly is a case in point: “We machine the metal barrel to very tight specs, and hold lens diameters and thicknesses to close tolerances,” Kopit noted. Finally, the primary, corrector plate, and correcting lens assembly are installed in an optical tube and aligned using a laser fixture.

Before it can leave the factory, every RASA must pass its Final Acceptance Test, or FAT. The FAT is carried out on an optical bench. In fact, it is the same fixture Celestron uses to test its EdgeHD SCTs. “We use a Canon 5D Mark III with a full-frame sensor. We focus on an artificial star image at the center of the field,” Kopit explains, “then point the RASA being tested so the image falls in each of the four corners of the frame. The center and all four corner images must be virtually identical.” If the corner images are not as sharp and tight as the center image, the tilt of the correcting lens assembly is adjusted so the on-axis and off-axis star images appear sharp at the same focus point. “When a RASA leaves the factory, it’s in good alignment,” said Kopit. “Although the user can adjust the tilt of the correcting lens assembly, it’s usually not necessary.”

Fig. 16: The Final Acceptance Test, or FAT, insures that every Rowe-Ackermann Schmidt Astrograph leaves the factory aligned and producing tight, sharp star images across the full field of view.

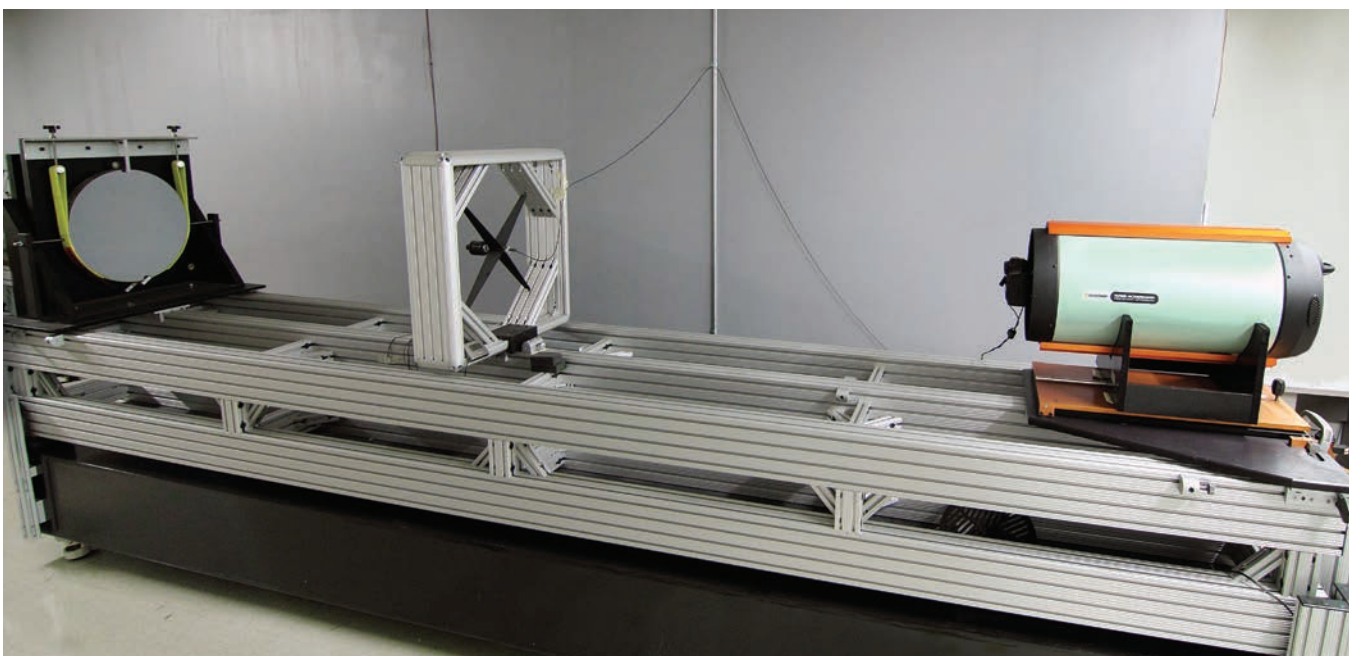

9. The RASA as a High Étendue Optical System

Astronomers measure the flux gathering capability of an optical system using a parameter known as étendue. Étendue, designated by ϵ , the product of the collecting area of the optical system, A , times the field of view of the image sensor, Ω , that is, $\epsilon = A\Omega$. A telescope's étendue is an effective measure of its power to both gather light and survey the sky.

How do telescopes commonly used by amateur astronomers compare for deep-sky imaging? In Table 2, you will find a list of astrographic telescopes used by amateur astronomers for deep-sky imaging, and for each system, the aperture, focal length, the field of view covered by a full-frame 36 × 24mm sensor, and the calculated étendue of the system.

Table 2: Étendue of Amateur Astronomers' Telescopes

| Telescope | Aperture (mm) | Focal Length (mm) | Area Coverage* (deg ²) | Étendue** cm ² deg ² |
|---------------------------|---------------|-------------------|------------------------------------|--|
| 14-inch RASA*** | 356 | 790 | 9.506 | 10120 |
| 11-inch RASA | 279 | 620 | 7.380 | 4779 |
| 10-inch Imaging Newtonian | 250 | 1000 | 2.837 | 1662 |
| 6-inch Imaging Newtonian | 150 | 750 | 5.043 | 1064 |
| FSQ 106ED | 106 | 530 | 10.099 | 1135 |
| TSA 102S | 102 | 610 | 7.624 | 793 |
| AT 115EDT | 115 | 805 | 4.378 | 579 |
| 10-inch Ritchey-Chretien | 250 | 2000 | 0.709 | 395 |
| 11-inch Edge HD | 279 | 2788 | 0.365 | 253 |
| Classic C8 | 203 | 2032 | 0.687 | 252 |
| 14-inch Edge HD | 356 | 3857 | 0.191 | 242 |

* Coverage in square degrees for a 36 x 24mm "full frame" sensor, except 14-inch RASA, with 49.1 x 36.8mm KAF-50100 sensor.

** Étendue is measured in cm²deg². Aperture area has been corrected for central obstruction. To convert to m²deg², divide by 10,000.

*** Proposed design.

The RASA's winning combination of large aperture and wide field of view place it at the very top. Below the RASA are imaging Newtonians equipped with a coma correcting lens; they rank high because they offer generous aperture plus a moderately wide field. Although apochromatic refractors may offer a wide field of view, their small aperture means they lack the RASA's light-gathering power, resulting in multi-hour exposure times. Traditional Ritchey-Chrétiens and Schmidt-Cassegrain telescopes afford plenty of light-gathering power, but their long focal lengths and resulting high focal ratios dictate much smaller fields of view. Neither aperture by itself nor field of view alone can produce an instrument with high étendue. The RASA's unique

combination of large aperture plus wide field of view places it at the top of the list.

The choice of image sensor is therefore critical in high étendue imaging. The physical dimensions of the camera's sensor, whether it is a CCD or CMOS sensor, determine the angular field of view and therefore control the étendue of the system. If you use the RASA with a small sensor, the result is a lower ability to search and survey the sky – but you still have the full benefit of the RASA's large aperture and fast focal ratio. And, as desirable as a large sensor might be, larger sensors cost more than small sensors. Because the RASA-11 offers so much optical capability at such a low price, it is hardly surprising that "big-chip" cameras able to exploit the RASA's full capacity and capability often prove to be more expensive than the RASA itself.

10. Adapting Image Sensors to the RASA

In an ideal world, it would seem a simple task to locate an image sensor at the focal plane of the RASA. In the real world it's a bit more complicated. The image sensor must be solidly mounted in the correct place, and light from the RASA needs to travel from the correcting lens assembly to the sensor without being blocked. Potential difficulties occur when the structures that support the image sensor intrude, preventing light from reaching the sensor, and resulting in vignetting that can range from mildly annoying to quite severe. To interface the image sensor optimally, think of the external volume between the RASA and the sensor as a "Do Not Obstruct" zone.

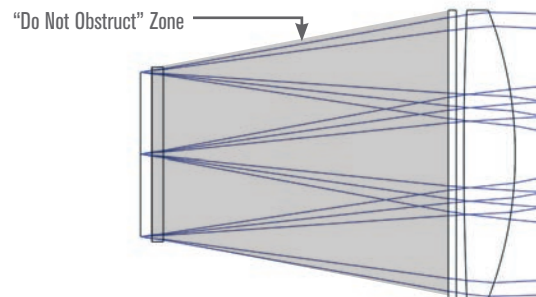

Fig. 17: The "Do Not Obstruct" zone is the region between the corrector lens and the image sensor. Anything that obstructs light passing through this volume causes light loss.

Internally, the RASA's optical system exhibits mild vignetting. After passing through the corrector plate, a small amount of off-axis starlight misses the rim of the primary mirror, and another small amount of light converging toward the correcting lens assembly gets clipped by the correcting lens housing. This vignetting is part of the RASA design; it falls off smoothly and is readily countered by standard flat-fielding methods. Even at the corners of a full-frame sensor (21.65mm off axis), vignetting amounts to a modest 23%. Figure 18 graphs the RASA's smooth "native" vignetting profile.

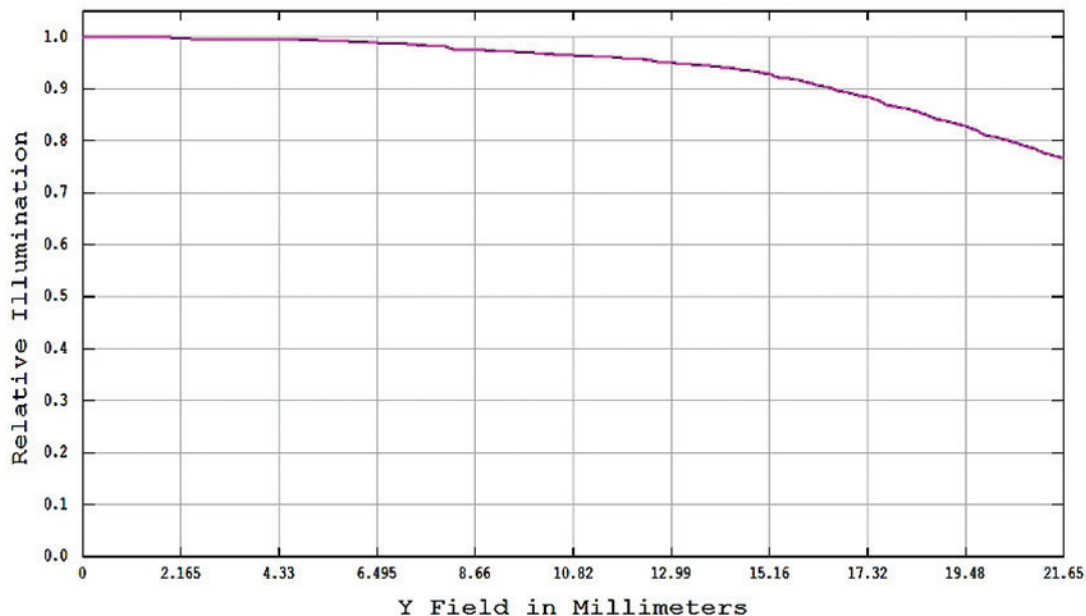

Fig. 18: With no external obstructions, the RASA displays a smooth and modest light loss to vignetting, amounting to 23% in the corners of a full-frame sensor. External obstructions will produce a sharp drop in the right-hand side of the curve.

“Aesthetic Imaging” with the RASA

What does the RASA offer you that other astrographs with the same focal length don't offer? The RASA gives extremely sharp images across a wide, flat field of view. The same is true of a high-end apochromatic flat-field astrograph. An imaging Newtonian with a coma corrector provides acceptable performance over most a full-frame format, too. The RASA's color correction might be a bit better, and its off-axis images a touch sharper, but in the end, any optic with a 620 mm focal length is an optic with a 620 mm focal length. Isn't that right?

We invite you to carry out an experiment with your DSLR camera and a good-quality camera lens with a 28 to 55 mm focal length. We suggest using the same lens you use for taking wide-angle pictures of the Milky Way. Place the camera on a tracking mount, select an ISO setting of 1600, and set the lens to $f/2.5$. (Although the RASA is $f/2.2$, its central obscuration makes it slightly slower. This is called the “T-number;” it's just like an “f-number,” but it also takes optical transmission into account. The RASA is T/2.5.) Focus carefully, and then take a 60 second exposure. You will capture splendid picture showing star clouds, clusters, nebulae, dark rifts – and your picture will be fully and properly exposed.

Now repeat the process, but this time set the focal ratio of your camera to the focal ratio of your favorite imaging telescope. Give your optics the benefit of the doubt, and don't correct for their central obscuration. For a typical imaging Newtonian, try shooting at $f/4.5$, for the apochromatic astrograph, take your pick among $f/5$, $f/6$, and $f/7$. For the Ritchey or the SCT, set the aperture to $f/8$, $f/10$, or $f/11$. Make the same 60-second exposure. You will have a picture that may be sharp, it may be well tracked, but it will definitely be underexposed. You can compensate, but an ISO setting of 6400, 12800, or 25,600 just don't give you the noise-free picture you hoped for. What to do?

Obviously, you can increase the exposure time. Try exposures of 120 seconds, 180 seconds, 300 seconds, and 600 seconds. You will find it takes 180 seconds at $f/4.5$ to get the same full exposure you got at $f/2.5$. At $f/5.5$, you need 300 seconds to reach full exposure, and at $f/10$, you're in for a 15 minute exposure time. In other words: the focal ratio matters.

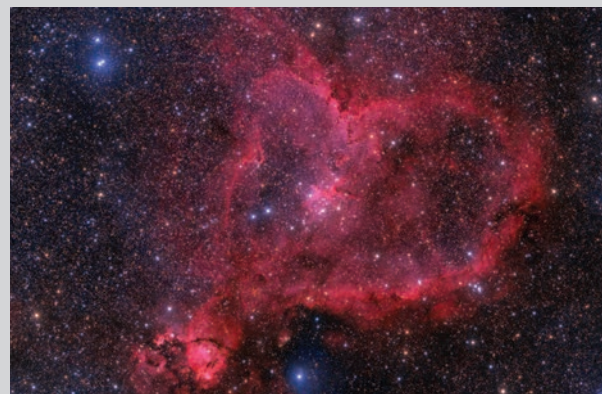

This RASA 11” image of the Heart Nebula (IC 1805) was taken by Jimmy Walker, Team Celestron member and pro Golfer, using an FLI Microline 11002 color camera. The image comprises of twelve 5-minute exposures stacked together.

When you put a good-quality DSLR at the focus of the RASA, you can cruise around the sky shooting nicely exposed images of the famous deep-sky objects in 60 seconds. You don't even need to guide! Drop the ISO setting to 400, get good polar alignment, expose for five minutes, and you'll get a deep, grain-free image of almost any deep-sky object you can name. Go for broke and shoot a dozen five-minute exposures, stack them, and you have an image that would have taken three hours to capture with an $f/4.5$ optic, five hours with an apochromatic refractor, and two entire nights with the conventional R-C astrograph or SCT.

That's what the RASA really offers the aesthetic deep-sky imager: efficient and effective use of the limited number of clear nights you get under a dark sky. The RASA's extraordinary light-gathering power – the combination of a fast focal ratio and a large aperture – puts lots of photons on the focal plane for your image sensor to capture. The RASA cannot do more than other optical systems of the same focal length and field of view, but it can do the same thing much faster. Five minutes with the RASA gets you an hour's worth of light collected by a top-of-the-line apochromatic refractor. And RASA images are tight, sharp, and free of color everywhere in the full-frame format field.

The location of the image sensor is external to the RASA optics and its placement should satisfy three conditions:

1. The sensor must be 72.8 ± 1 mm from the tilt collar on the RASA.
2. The sensor should be perpendicular to the optical axis of the RASA to 0.01° or better.
3. Light rays from the RASA optics should reach the sensor without encountering any obstacles.

The first two conditions are fairly easy to satisfy. If the components of the adapter are machined from metal, the necessary distance is a matter of design, and perpendicularity is assured by the machining process. The RASA end of the adapter should be similar to that of the adapters supplied by Celestron with every RASA, and the sensor end should be threaded, or have a dovetail or bayonet mount matching that of the camera body that holds the sensor.

The third condition is considerably more difficult to meet. At $f/2.2$, light cone from the RASA's optical system is wide where it exits the correcting lenses, so the skinny cylindrical extensions typical of the adapters on refractors and SCTs simply will not do. Instead, the inside of the adapter should be as open as possible to avoid blocking light and causing vignetting; it should take the form of a squat, stout cylinder or broad, truncated cone.

The following points summarize adapter types for major camera and sensor types:

A. DSLRs

DSLR camera bodies have a built-in obstruction that is impossible to change: the reflex mirror. The mirror is housed in a deep, narrow structure called the "mirror box". Standard camera lenses sit immediately in front of the mirror, so light from the lens diverges and avoids being blocked by the mirror. In contrast, RASA's broad converging light cone is clipped on all four edges, and most strongly clipped along the side with the reflex mirror. Celestron provides two DSLR-oriented adapters with each RASA.

B. MILCs

Mirrorless interchangeable-lens cameras are relatively new to the market. These cameras have no mirror; instead, the sensor is read out continuously and displayed on a screen on the camera body. Because there is no mirror, the camera body can be thinner, and can provide much more open access to the image sensor. MILCs will become more popular as their merits become apparent. MILCs can be mounted on a RASA using standard adapter (with some vignetting) or custom adapters (with little or no vignetting).

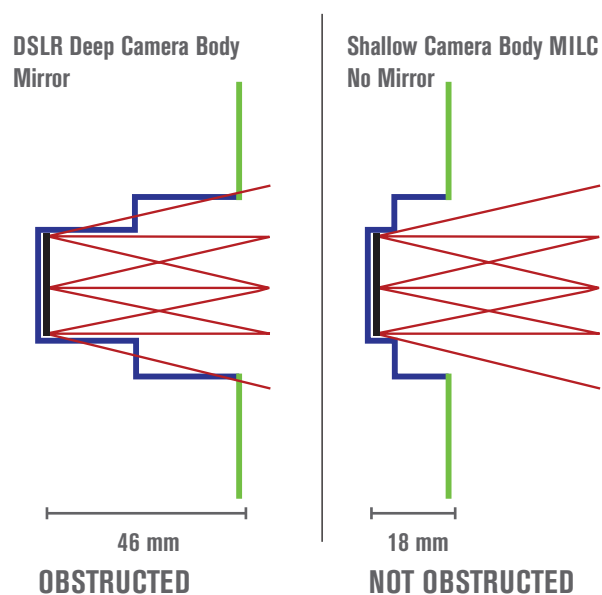

Fig. 19: The DSLR, with its deeply recessed sensor and obstructing mirror box, will block some of the RASA's light from reaching the edges of a full-frame sensor. The MILC does not have this problem.

C. Astronomical CCD Cameras

Without a doubt, cameras designed for long-exposure deep-sky astronomy most fully exploit the RASA's potential. They offer the highest quantum efficiency, the lowest noise, and the best options for dark current subtraction and flat-fielding. CCDs are available in both monochrome and one-shot-color formats. CCD cameras with relatively small sensors can be mounted using Celestron's standard DSLR adapters. If you have a CCD with a sensor larger than 16mm diagonal, use it with a custom-made adapter. If the image sensor is mounted near the front of the camera housing, you should be able to design an adapter that causes little or no external vignetting.

D. Video and Real-Time Cameras

The aperture and speed of the RASA's optics make it ideal for "real-time" or "live-view" observing with speeds as fast as four frames per second. And, because the sensors in these cameras are small, Celestron's standard adapters work well with them.

Celestron includes two general purpose adapters with each RASA. One adapter is for T-system cameras. Many cameras use the T-system: a standard 42×0.75 mm female thread with a standard 55mm flange-to-sensor distance. The adapter has a matching 42×0.75 mm male thread. Any T-system camera mounted on the adapter will be at the correct back-focus distance. However, the small inside diameter of the T-system barrel intrudes into the "Do Not Obstruct" zone and prevents some light from reaching the corners of the image sensor.

The second Celestron adapter is similar to the T-system adapter, but has a “T-wide” 48 × 0.75mm (M48) male thread. The larger diameter opening reduces, but does not entirely eliminate, vignetting from the adapter.

Other standard adapters including T-mount, T-wide, T-to-C, and C-mount, as well as adapters for specific astronomical CCD cameras are available from astronomical equipment dealers.

For custom adapters, consult the manufacturer of the CCD camera you are considering. The design and dimensions needed to mount CCDs vary considerably from maker to maker. PreciseParts (www.preciseparts.com) offers a custom design and machining service with their on-line “Build an Adapter” application. The required part is made to your specifications and shipped directly to you.

As handy as it may be, do not accept the first software-designed adapter design you get. Analyze how light from the RASA optics flows through the adapter, and make sure nothing intrudes into the RASA’s external “Do Not Obstruct” zone. Non-obstructing adapters will, as a general rule, be hollow cylindrical or bell-shaped structures with a RASA flange at one end and, at the image-sensor end, as wide open as the camera’s flange, bayonet, or threads will allow. Refer to Appendix B for more details.

11. Imaging with the RASA

For amateur astronomers, the RASA’s fast focal ratio and wide field of view favor imaging colorful hydrogen-rich nebulae and intense star-forming regions. The Pleiades, Orion Nebula, the Trifid and the Lagoon, Markarian’s Chain in Virgo, Eta Carinae, and the Large Magellanic Cloud are calling for your attention!

For imaging deep-sky objects with the RASA, here’s what every potential imager must consider:

A. Obscuration

Because the camera is mounted on the front of the telescope, the camera should be compact. The correcting lens assembly of the RASA acts as an obscuration 114mm in diameter, so cameras that fit within a 114mm circle will block no additional light. However, even bulky DSLR cameras that protrude outside the 114mm circle add little additional obscuration. CCD sensors mounted in slender cylindrical camera bodies (up to about 125 mm diameter) are best, and add little or no additional obscuration.

B. Obstruction

The adapter that holds the camera body should intrude as little as possible into the “Do Not Obstruct” zone (see Figure 17). A well designed adapter will introduce no more vignetting than absolutely necessary.

C. Sensor format

One-shot-color and monochrome CCDs are good, especially those housed in a slender camera body. With DSLRs and MILCs, anything goes! Full frame, APS-C, and Four-Thirds DSLRs all work well. Vignetting affects full-frame DSLRs far more than it does the smaller formats, so many users will prefer the lower cost and greater ease of use of the APS-C and Four-Thirds formats despite their reduced field of view.

Table 3: Image Sensor Formats with the RASA-11

| Format | Dimensions (mm) | Area (mm ²) | Angular Field | Field Area |
|----------------------------|-----------------|-------------------------|---------------|------------|
| KAF-16803 | 36.8 x 38.8 | 1354 | 3.4° x 3.4° | 11.6° |
| 35mm “Full Frame” | 36.0 x 24.0 | 864 | 3.3° x 2.2° | 7.4° |
| KAI-11002 | 36.0 x 24.0 | 864 | 3.3° x 2.2° | 7.4° |
| APS-H (Canon) | 28.7 x 19.0 | 548 | 2.7° x 1.8° | 4.7° |
| APS-C (Nikon, Sony, ...) | 23.6 x 15.7 | 370 | 2.2° x 1.5° | 3.2° |
| APS-C (Canon) | 22.2 x 14.8 | 329 | 2.1° x 1.4° | 2.8° |
| KAF-8300 | 18.0 x 13.5 | 243 | 1.7° x 1.1° | 1.8° |
| KAI-10100 | 17.9 x 13.5 | 241 | 1.7° x 1.1° | 1.8° |
| Four-Thirds (Olympus, ...) | 17.3 x 13.0 | 225 | 1.6° x 1.1° | 1.7° |
| KAF-3200 | 14.9 x 10.2 | 152 | 1.4° x 0.9° | 1.3° |
| Nikon 1 | 13.2 x 8.8 | 116 | 1.2° x 0.8° | 1.0° |

D. Imaging by wire

All CCD cameras are controlled remotely via USB cable. With DSLRs and MILCs, it is possible but not practical to operate the camera manually. Instead, the observer should be able to operate the camera from a PC or Mac via USB interface cable. The camera control software should support Bulb exposures (that is, exposures of any length), intervalometer shooting (multiple exposures at a pre-set interval), and Live View (displaying a continuous video image from the camera). Many cameras come with suitable remote imaging software in the box. You can download excellent and inexpensive aftermarket remote-operation programs for Canon and Nikon cameras.

E. Power

If possible, operate the camera with external power. A serious imaging session can easily run six to eight hours. The camera’s batteries in a DSLR must be able to operate the camera reliably for at least this long. If you must operate on camera battery power, have several extra fully charged batteries on hand.

F. Dew Shield

It's a must-have! It is important to shield the camera body from stray light that can enter the optics and fog images. A dew shield at least 30 cm (12 inches) long will help to prevent dew from forming on the dew-vulnerable corrector plate of the RASA.

G. Heater strip:

In addition to the dew shield, a few watts of heat from a heater strip will prevent dew from fogging the corrector plate during an imaging run. It is better to prevent dew from forming than to try to remove it once the corrector plate is dewed or frosted.

Of course, you must also be able find targets, so a go-to mount and/or a good finder telescope are necessities. If you wish to make long exposures, it's easy to mount a guide telescope and guide camera on the top dovetail that's included with the RASA. Once set up, however, the RASA's fast optical system keeps exposure times short, so capturing great images with it remains a pleasure.

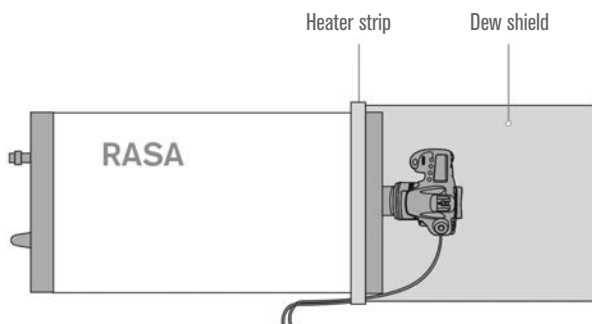

Fig. 20: The dew shield serves three important roles: 1) it prevents dew from forming on the correct plate, 2) it shields the camera from stray light that can be reflected into the RASA, and 3) it prevents skylight outside the field of view from reducing image contrast.

12. Imaging with a DSLR Camera

For several years, the Canon 60Da has been a favorite among astro-imagers – the “a” designation meaning that the camera’s internal filter has enhanced transmission of H α light. Although it sells at a premium price over the standard Canon 60D, it has an 18 megapixel sensor in APS-C format, and has shown itself as a proven performer.

The Nikon D810A is an astronomical (“A”) version of the high-end Nikon D810 that comes from the manufacturer with enhanced sensitivity at H α . At 36 megapixels, the images offer plenty of resolution, but its mirror box partially obstructs the frame edges, so vignetting with this and other full-frame DSLRs will inevitably be significant.

To gain the benefit of high sensitivity to H α without paying a premium price, however, third-party suppliers

will modify (or “mod”) most prosumer and professional grade DSLRs for a few hundred dollars. Modified cameras are in wide use among astro-imagers. The Canon EOS line is very popular for modding, as are the advanced and high-end Nikon offerings.

On the RASA, ordinary APS-C DSLRs perform extremely well. Although “modding,” that is, removing the infrared cutoff filter that also reduces H α light, improves a camera’s sensitivity to H α , standard non-modded DSLRs render objects such as the Andromeda galaxy, reflection nebulae such as dust enveloping the Pleiades, star clusters like the Double Cluster in Perseus, and galaxies in the Virgo Cluster exactly the same as a regular DSLR would. Furthermore, an off-the-shelf DSLR renders gaseous nebulae with greater subtlety than a modified camera does: nebular gases appear a natural “electric pink” in color, rather than the saturated “crimson” hue of a modded sensor. Before spending the money and voiding your DSLR’s warranty, shoot some “baseline performance” images with the RASA. You will not regret it.



Fig. 21: A DSLR connected to the RASA. Note the dovetail bar on top of the optical tube, this provides a mounting platform for optional imaging equipment.

13. Imaging with MILCs

Mirrorless Interchangeable-Lens Cameras (MILCs) are fast becoming popular. All DSLRs have a reflex mirror that flips out of the light path just before the camera makes an exposure. Mirrorless cameras instead capture the image continuously and display it on a viewing screen. By allowing interchangeable lenses, MILCs offer the advantages of using different lenses without the drawbacks of the DSLR’s deep camera body and moving reflex mirror.

Five-Minute Exposures!

The images shown here are 5-minute exposures taken with a Nightscape CCD camera on an 11-inch RASA telescope. With the RASA, lengthy exposures are a thing of the past. Deep-sky images are easy, fun, and quick!



Pleiades Star Cluster, M45

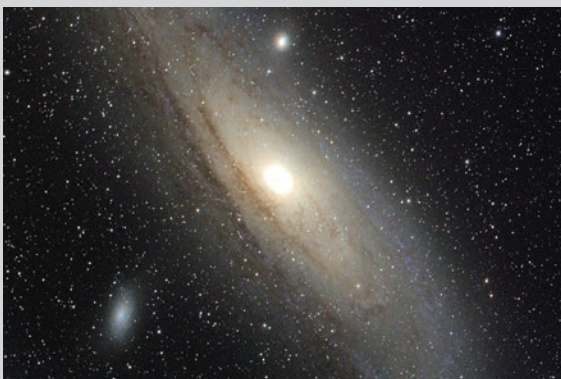

Andromeda Galaxy, M31



Rosette Nebula, NGC 2237

Images by Richard Berry

For astronomical imaging, a rising contender is the full-frame format Sony A7S. The A7S (or a7S) has a 12 megapixel sensor and rather than burying the sensor 45mm deep inside camera body, the flange-to-sensor distance is only 18mm. With a suitable adapter, vignetting caused by the camera body and reflex mirror can be eliminated or greatly reduced. Although the pixel count is small by modern standards, its 8.4-micron pixel size is actually well matched to the spot size of the RASA. The stock a7S body can be modified for enhanced sensitivity to H α .

Other makers will undoubtedly join the movement toward mirrorless cameras. Canon has introduced the EOS M product line with an APS-C sensor size and an 18mm flange-to-sensor distance. To be useful for astrophotography with the RASA, however, remember that you must be able to control the camera from a computer using its USB interface cable. To take advantage of the more accessible sensor, however, you must use a RASA adapter designed to reduce or eliminate vignetting.

14. Imaging with One-Shot-Color CCD Cameras

CCD cameras come in two flavors: monochrome and one-shot-color. In a monochrome CCD camera, pixels on the sensor array are all the same. To make a color image, three exposures are made through color filters. The images are monochrome (i.e., black-and-white) and must be combined to produce color. In one-shot-color CCDs, the sensor is covered with an array of tiny red, green, and blue color filters called a Bayer array. Adjacent pixels capture different wavelength bands, so that afterwards a full-color image can be reconstructed from the matrix of differently filtered pixels.

The selling point of one-shot-color cameras is they capture a color image in a single exposure. Their image acquisition software reconstructs a full-color image from the mosaicked Bayer-array data. The primary disadvantage of one-shot-color cameras is that the Bayer array filters reduce the amount of light reaching the CCD, necessitating longer exposure times—but the RASA's f/2.2 focal ratio means that exposures seldom exceed five minutes, and the image obtained in that time is deeper and richer than slower astrographs capture in an hour's worth of stacked exposures.

For imaging at sites with heavy light pollution, the RASA's internal clear glass filter (located inside the tilt collar) can be replaced with a special light pollution reduction filter that Celestron developed in cooperation with Astrodon (www.astrodon.com). The filter is an exact replacement for the clear filter, except that it reduces the effect of city lights without distorting the color balance of your one-shot-color images.

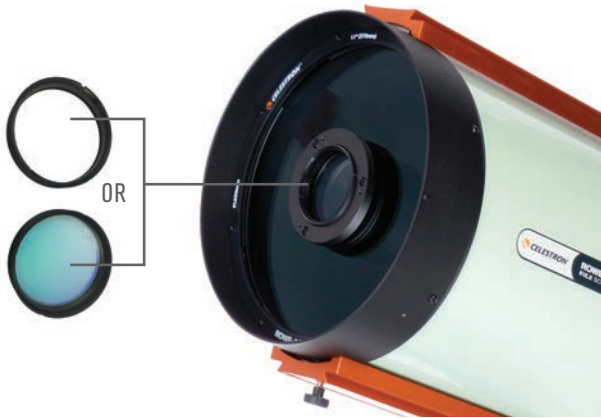

Fig. 22: The RASA's integral clear filter ensures optimal optical performance, it should be removed when using another filter in the light path. It can also be replaced with an optional light pollution filter which was developed in collaboration with Astrodon.

Manufacturers of one-shot-color CCD cameras include Artemis Atik, QSI, QHYCCD, Starlight Xpress, Apogee, SBIG, and FLI. Since the RASA design is optimized to produce a full-frame 43.3mm diameter image with a modest 23% vignetting in the very corners of the image, if you can afford a full-frame format camera, you'll be able to capture a large chunk of sky in a single exposure. Even better, in a single night you could shoot a mosaic with a dozen images that covers the region from the Belt Stars to the Horsehead to the diffuse nebulosity south the Orion Nebula!

15. Imaging with Monochrome CCD Cameras

Monochrome CCDs offer greater sensitivity than one-shot-color cameras because there is no light-absorbing Bayer filter mask on the sensor. With no filter, the CCD responds to light from the near ultraviolet through the visible spectrum and into the near infrared. For applications that demand the greatest space-penetrating power in the shortest time – such as searching for comet or imaging orbiting space debris – a monochrome CCD camera with a readily accessible sensor and a compact camera body is the way to go.

To make color images with a monochrome CCD, the usual technique is to shoot images through broadband red, green, and blue filters, or to shoot using narrowband OIII, SII, and HA filters. Because the RASA's optics are designed for a single 2mm thick filter in the optical path, if you wish to use another filter, remove the internal clear glass filter located inside the RASA's tilt collar. If two filters are in the optical path at the same time, the RASA's performance will be affected.

Observing programs that require a filter usually require more than one filter, so the filters are mounted in a filter

rotating wheel. A small motor turns the wheel so that different filters can be inserted into the light path without manual intervention. All too often though, the filter wheel is considerably larger than the camera body itself, and when placed at the focus of a RASA, the filter wheel blocks a considerable amount of light. There is currently no easy solution to the filter-wheel dilemma, although custom solutions do exist. For example, filters can be mounted in a sliding drawer and manually inserted into the light path.

When they conceived the RASA, Dave Rowe and Mark Ackermann selected as their design target a CCD camera that would be especially effective and appropriate. The camera they choose is the FLI Microline ML11002M CCD camera. The anti-blooming interline KAI-11002 sensor has 4008 × 2672 array is 9 micron pixels, and can be cooled to 60° C below ambient. The camera body is 3.7 inches square, so it blocks very little additional light. An excellent alternative is the Artemis Atik 11000M, also using same KAI-11002 sensor. With a back-focus distance of 15mm and a camera body diameter of 125mm, this camera is not only optically and physically well-matched to the RASA, but also considerably less expensive than the FLI model.

However, it is possible to push the RASA's field to a full 52mm diameter with a 16 megapixel sensor such as the KAF-16803. Vignetting reduces the illumination at the corners by about 40%, but proper flat-fielding overcomes the problem. FLI's Microline ML16803M on the 11-inch RASA can and does produce outstanding images to the very corners of the image.

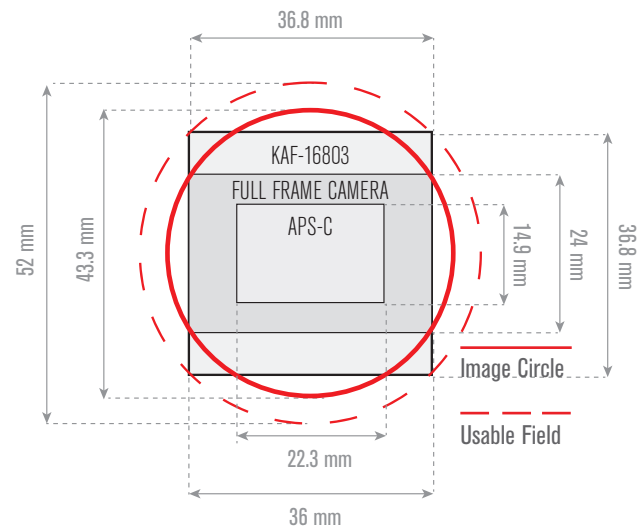

Fig. 23: Larger CCD sensors, even the Kodak KAF-16803, work well with the RASA 11". Its 52mm diagonal extends outside the optimized image circle, but the RASA still provides good illumination and performance within the "useable field".

16. Big! Fast! Wide! Sharp!

Celestron's telescope testing observatory is located at their headquarters in Torrance, CA, a place not known for pristine dark skies. In fact, these semi-urban skies are typical of the skies many Celestron owners experience on a nightly basis. "If we did all of our testing under perfect skies," says Celestron Product Manager of Astronomy, Bryan Cogdell, "we would not be serving our customers well. It's important that we know and understand how our telescopes operate under the typical suburban and urban skies."

"For those who are new to astronomical imaging, as well as those who have learned astroimaging the hard way, the RASA comes as a revelation," said Cogdell. "The newcomers have heard stories about hours-long exposure times," he said, "and the old-timers have experienced those all-night sessions imaging at f/8 and f/10. Those guys have done it all: polar alignment, lengthy exposures, autoguiding, and stacking! They have paid their dues."

For them, the RASA comes as new experience. "With the ISO of their camera set to 6400, old-timers make a single 15-second exposure at f/2.2 and see a creditable image. They are totally amazed! If they drop the ISO to 1600 and expose for 60 seconds, they see an image that would have taken 20 minutes at f/10." There's no need to guide for just 60 seconds; quick polar alignment is good enough. "With minimal complexity," notes Cogdell, "veterans can apply their hard-won skills, shoot a dozen five-minute exposures at ISO 400, stack them, and get rewarded with the finest images they've ever taken."

As the party responsible for testing and evaluating the RASA from the first, Cogdell says he's been consistently impressed. "With the RASA," he says, "we have given observers the ability to do fast imaging, but we also need to make people aware that 'real time astronomical imaging' is now possible with a high-étendue telescope." The coming generation of high-sensitivity CMOS sensors means you will capture and watch deep-sky objects on a computer screen, real-time, moving smoothly as you move the telescope. "It's going to be great for group viewing and public star nights. You press 'go-to M51' and everyone sees the Whirlpool as it glides into view."

Another new technology is image live stacking. Atik's Infinity camera makes imaging far more intuitive. "The CCD is small, but you watch as the image grows stronger and the noise drops away. The focal length of the RASA gives you a field of view perfectly suited to viewing the Messier objects," Cogdell explains. Software takes care of image alignment and stacking, even when the telescope is not perfectly polar aligned. "High étendue gives the RASA a big advantage. With other telescopes, you need focal reducers; with the RASA, you're ready-set-go at f/2.2."

For serious aesthetic imaging," says Cogdell, "I am anxious to try multi-frame mosaics. Advanced amateurs are doing mosaics now, but with conventional low-étendue systems, it takes forever to gather the necessary number of images." With the RASA, everything you need for a multi-frame mosaic can be captured in a single night. "For some imagers, the seven square degrees of

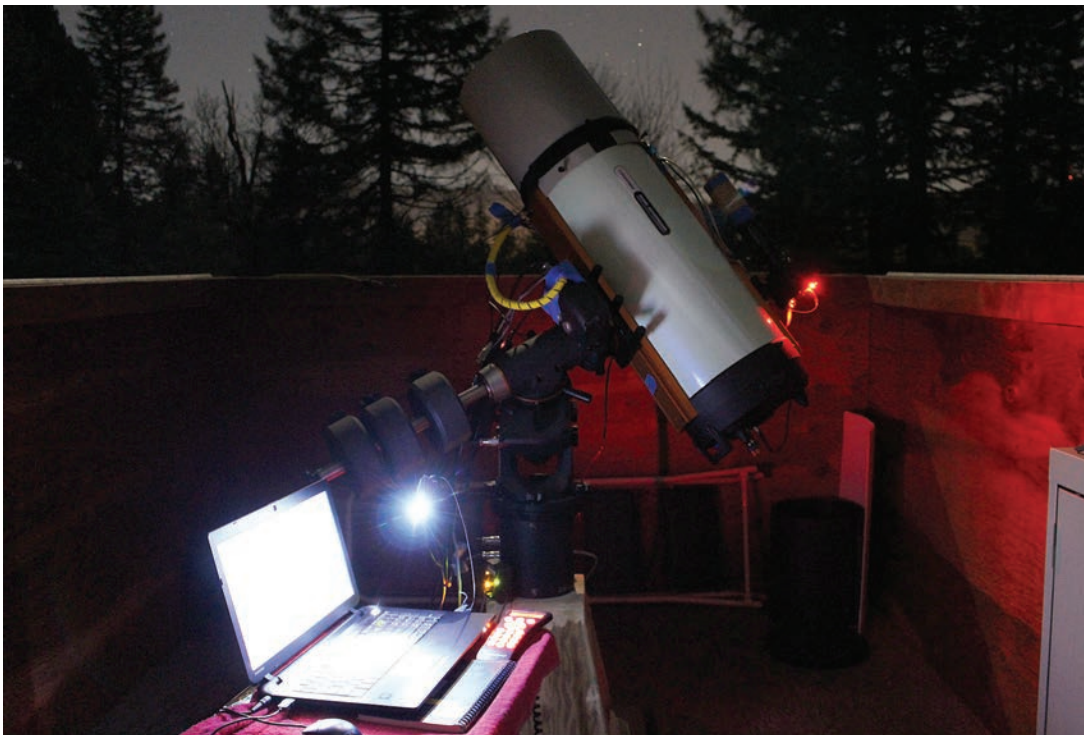

Fig. 24: The truest satisfaction with an astrograph comes when you're under the stars. As this photo was taken, the RASA was busy capturing images of Comet Catalina.

sky you get in a RASA frame is simply not enough! But gather 30 minutes of data with your RASA for each field, and you can complete a two-by-three six-panel mosaic in a couple of hours! Stitch the images together and you create a new perspective on the greater Perseus area.”

“I’ve tested the RASA with Canon’s 60Da and the full-frame 5D Mark III, as well as a QHY11 CCD. Under our bright skies, we had some problems at first with vignetting, so we had to crop the images. After we shot some good flat frames, we got good stuff even from our suburban/city location.”

“For beginners,” says Cogdell, “the adapters we include with every RASA make it easy to attach any

DSLR camera with an APS-C format sensor and get great results right from the start. That’s probably the best way to start using the RASA.” But, as Cogdell admits, “it’s easy to outgrow what the DSLR can do. For aesthetic imaging under good to excellent skies, you probably can’t beat the power and simplicity of a good full-frame one-shot-color CCD mounted on a non-obstructing adapter.” The combination of high-étendue optics with an easy-to-use sensor produces amazing deep-sky, wide-field color images in an hour’s exposure time. “In the hands of an experienced amateur astronomer,” declares Cogdell, “the RASA is the ultimate astrograph.”

Fig. 25: Celestron’s Bryan Cogdell enjoying a night of imaging with the RASA 11” from a dark sky location.



References

Ackermann, Mark, An Overview of Wide-Field-Of-View Optical Designs for Survey Telescopes, Proceedings of the Advanced Maui Optical and Space Surveillance Technologies Conference (AMOS2010), held in Wailea, Maui, Hawaii, September 14-17, 2010.

ATLAS Project, Asteroid Terrestrial-impact Last Alert System, <http://fallingstar.com/home.php>, 2015.

Browsers, A., Achievements in Optics, Elsevier, New York, 1950.

LSST Corporation, LSST Optical Design, <http://www.lsst.org/search/content/etendue>.

PS1 Science Consortium (Pan-STARRS)t, Wide-Field Imaging, <http://pan-starrs.ifa.hawaii.edu/public/design-features/wide-field.html>.

Tyson, J. Anthony, New generation wide-fast-deep optical surveys: petabytes from the sky, Highlights of Astronomy, V 14, IAU XXVI General Assembly, 2006.

Woodbury, David O., The Glass Giant of Palomar, Dodd, Mead, & Co., New York, 1946.

RASA 11-inch vs. Palomar Sky Survey

How do images taken with an 11-inch f/2.2 RASA compare the famous Palomar Sky Survey? At left is a stack of twelve 5-minute exposures versus a 30-minute red-filtered photograph made for the POSS II survey with the 48-inch f/2.5 UK Schmidt Telescope on the right. The RASA has better SNR (Signal-to-Noise Ratio) and has a deeper limiting magnitude, but UKSTU's 120 inch focal length provides better spatial resolution than does the RASA's 24 inches focal length. It's a dramatic demonstration of how much better the tools of the astronomers have become. The nebula is IC359 in Taurus.



279 MM f/2.2 Rowe-Ackermann



1200 MM f/2.5 UK Schmidt Telescope

APPENDIX A: Rowe-Ackermann Schmidt Astrograph Specifications

| | |
|--------------------------------------|---|
| Optical Design | Rowe-Ackermann Schmidt |
| Aperture | 279 mm |
| Focal Length | 620 mm |
| Central Obscuration | 114 mm |
| Focal Ratio | f/2.22 |
| Design Wavelength Range | 400 to 700 nm |
| Design Linear Field of View | 43.3 mm |
| Design Angular Field of View | 4.00 degrees |
| Aperture Collecting Area | 64900 mm ² |
| Field of View, 36 × 24 mm Sensor | 3.32 x 2.22 degrees Variable |
| Étendue, Full Frame Sensor | 4779 cm ² deg ² |
| Back Focus, M42 Camera Adapter | 55.0 mm |
| Back Focus, from Reference Surface | 72.8 mm |
| On-Axis RMS Spot Size | < 4.00 microns diameter |
| Everywhere RMS Spot Size | < 4.50 microns diameter |
| Encircled Energy(400-700 nm) | > 90% inside 7.5 micron circle |
| Clear Optical Filter, clear aperture | 68 mm |
| Clear Optical Filter, diameter | 72 mm |
| Clear Optical Filter, thickness | 2.1 mm |
| Clear Optical Filter, coating | Broadband AR multi-coated |
| Optical Filter, thread dimensions | 75 mm x 0.75 mm |
| Image Scale (arcseconds per pixel) | 0.33 x pixel size in microns |
| Vignetting, Relative Illumination | 100% at 5 mm off-axis 96% at 10 mm off-axis 93% at 15 mm off-axis 80% at 20 mm off-axis 77% at 21.65 mm off-axis (edge of field design) |
| Optical Coating, Primary Mirror | Starbright XLT |
| Optical Coating, Schmidt Plate | Broadband AR multi-coated |
| Optical Coating, Corrector Lenses | Broadband AR multi-coated |
| Focuser | Feather Touch Microfocuser |
| Focuser Rate | 0.10 mm/turn (fast focus knob) |
| Focuser Direction | CCW moves mirror forward |
| Mirror Support Clutches | Two |
| Cooling Fan | 12 VDC, tip polarity + (positive) |
| Maximum Camera Weight | 10 kg (22 pounds) |
| Total Weight, Telescope Kit | 20 kg (43 pounds) |
| Optical Tube Length | 840 mm (33 inches) |
| Optical Tube Diameter | 315 mm (12.4 inches) |
| Mounting | Heavy-duty dovetail rails top and bottom. |

APPENDIX B: Custom Camera Adapter Design Considerations

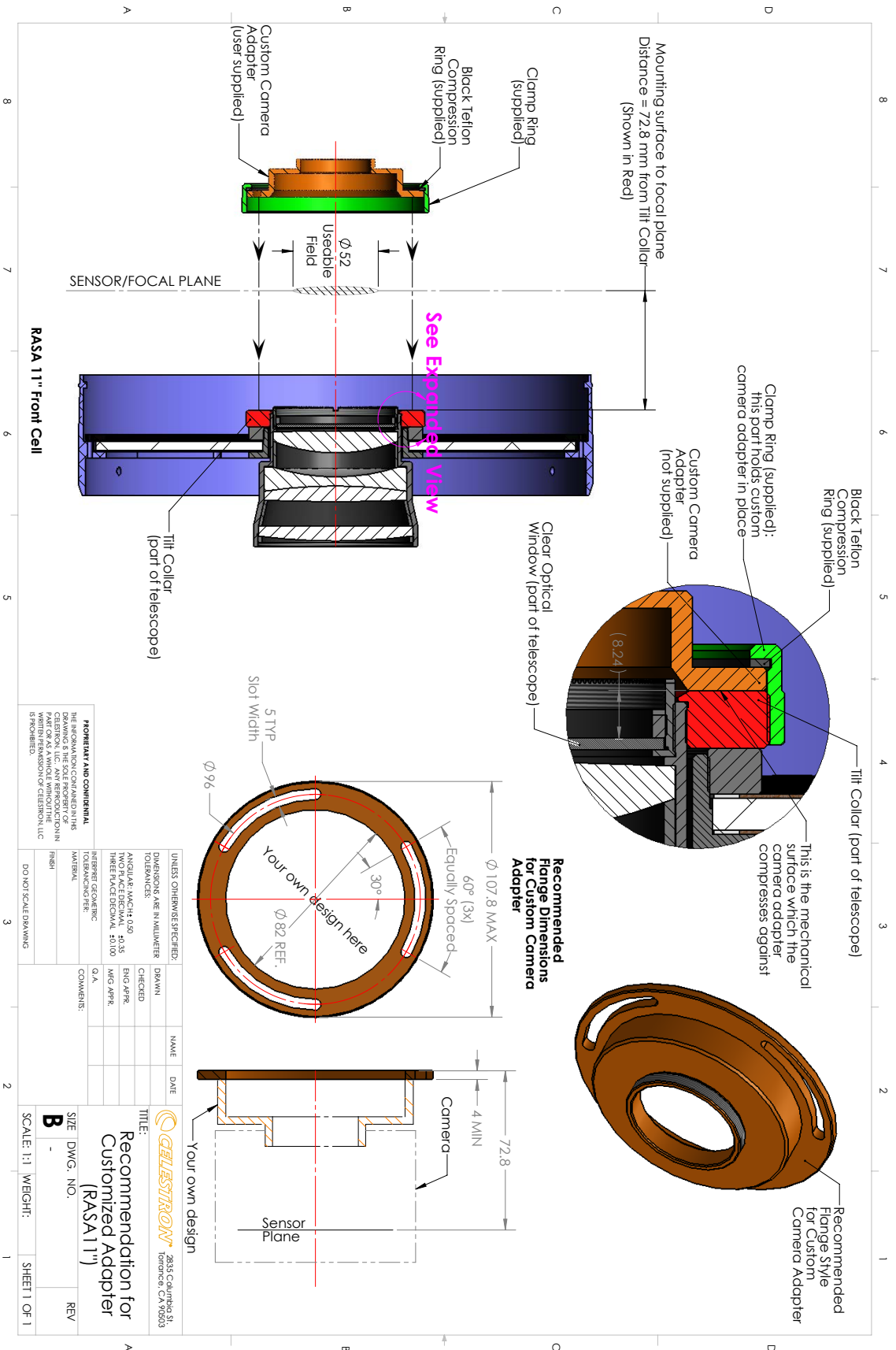

APPENDIX C: Science with the RASA

Because of its high étendue, the RASA is an exceptionally science-capable optical system. The combination of large aperture, fast focal ratio, and wide field combine to the benefit of the science observer. This is especially true in programs that require large numbers of images or large swaths of sky to be taken and searched rapidly.

Variable Star Photometry

One of the strongest contributions to science from amateur astronomers is through photometry of variable stars. The American Association of Variable Star Observers (AAVSO), the Center for Backyard Astrophysics (CBA), and the British Astronomical Association (BAA) are among the organizations that run active variable-star programs. The advent of CCDs increased both the number and precision of the work done by these groups.

To make an observation, the telescope points to a field containing a program star, makes a series of images through one or more color filters, then moves to the next program star. One telescope can visit hundreds of stars per night, or it may dwell on a single star all night long. The images are then calibrated and the magnitude of the stars are measured relative to comparison stars in the same field of view.

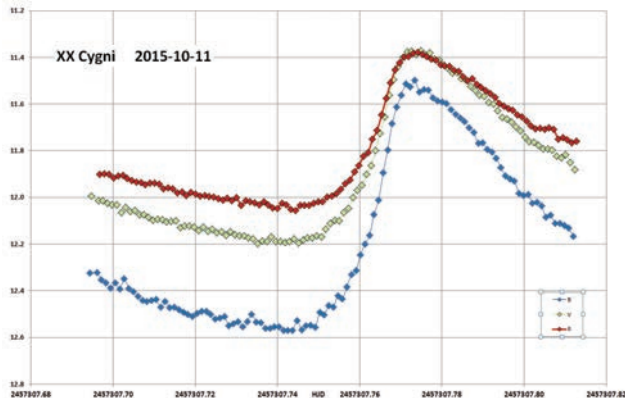

The star XX Cygni goes through a complete pulsation is just over three hours. XX Cygni has been followed for over 100 years. To check for on-going changes in the period of the star, the observer used the versatile 11-inch RASA to make alternating 15-second CCD images through photometric B, V, and R filters. Plotting the light curve gave the time of maximum light to better than a minute.

Asteroid Photometry

Amateur astronomers have made significant contributions to science by making light curves of asteroids. From a light curve, it is possible to determine the rotation period and pole orientation of the asteroid. The wide field of RASA combined with the large aperture makes it possible to follow an asteroid for multiple nights while using the same set of comparison stars, resulting in more homogenous data.

Comet Science.

Although professional observatories using telescopes similar to the RASA have largely supplanted amateur comet searches, amateurs continue to contribute by following comets and measuring their changing brightness. The light curve of a comet during an apparition may hold surprises as the comet brightens (or fails to brighten) and undergoes outbursts of activity.

Nova and Supernova Searching

So much sky and so few telescopes! Novae pop up unexpectedly in rich Milky Way fields, while supernovae appear in and around distant galaxies. Regular surveillance programs carried out by amateur astronomers can and do turn up both types of exploding stars.

LEO Object Spotting

Spotting and following Earthy-orbiting satellites has become an exoteric hobby among space enthusiasts. National governments track their satellites with fast, wide-field optics similar to the RASA, so it's only natural that amateur space hobbyists have turned to the RASA. Their targets include spy satellites, discarded booster rockets, space observatories, debris from satellite collisions, and assorted debris down to the basketball size range. To spot objects in LEO, the search instrument stares into space making short exposures, while a dedicated computer processes images looking for moving objects. Pairs of such imaging systems located a few kilometers apart can locate objects in space and determine their orbits.

Search for Near Earth Objects (NEO)

Our planet has been and will be hit again by a class of asteroids called Near Earth Objects. NASA and other space agencies are actively surveying the skies to identify and classify all objects that pose a danger to life here, and they are using instruments like the RASA to do so. The Catalina Sky Survey, Pan-STARRS, LINEAR, Spacewatch, NEOWISE, and the PS1 Consortium all employ fast, wide-angle optics in search of these objects. Of course, their optics may be fancier – an aperture measured in meters, a many-degrees field of view, and gigapixel CCD cameras – but there will never be enough eyes watching the sky.

“Amateur satellite trackers need the wide field and large aperture of an instrument like the RASA. Satellites move quickly, so you need to capture their light in seconds,” noted optical designer Mark Ackermann, “and with exposure times of a minute or two, you can catch Earth-crossing asteroids and comets.” The RASA's high étendue also makes it suited for supernova searches. In each case, the name of the game is to cover lots of sky in a short time, then cover it all again a few nights later to look for changes. “The ATLAS Project, funded by a \$5M NASA grant, will search using two 500 mm aperture f/2 telescopes with fields 7.4 degrees on a side. A 14-inch version of the RASA could, for \$10,000, do the same, and falling not far behind in capability, at a tiny fraction of the cost.”

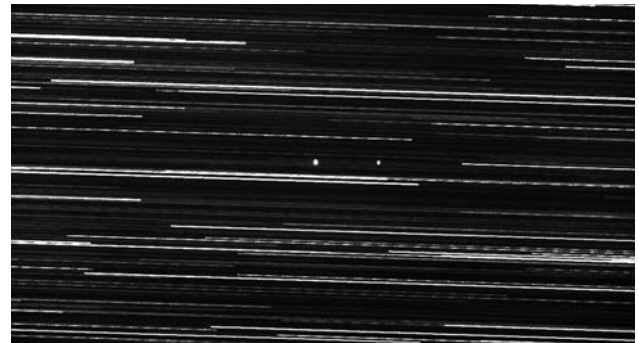

With the RASA pointed to a location in the sky (and no equatorial tracking), satellites in geosynchronous orbit will stay stationary in the field of view while stars will appear as streaks. Image by Richard Berry.

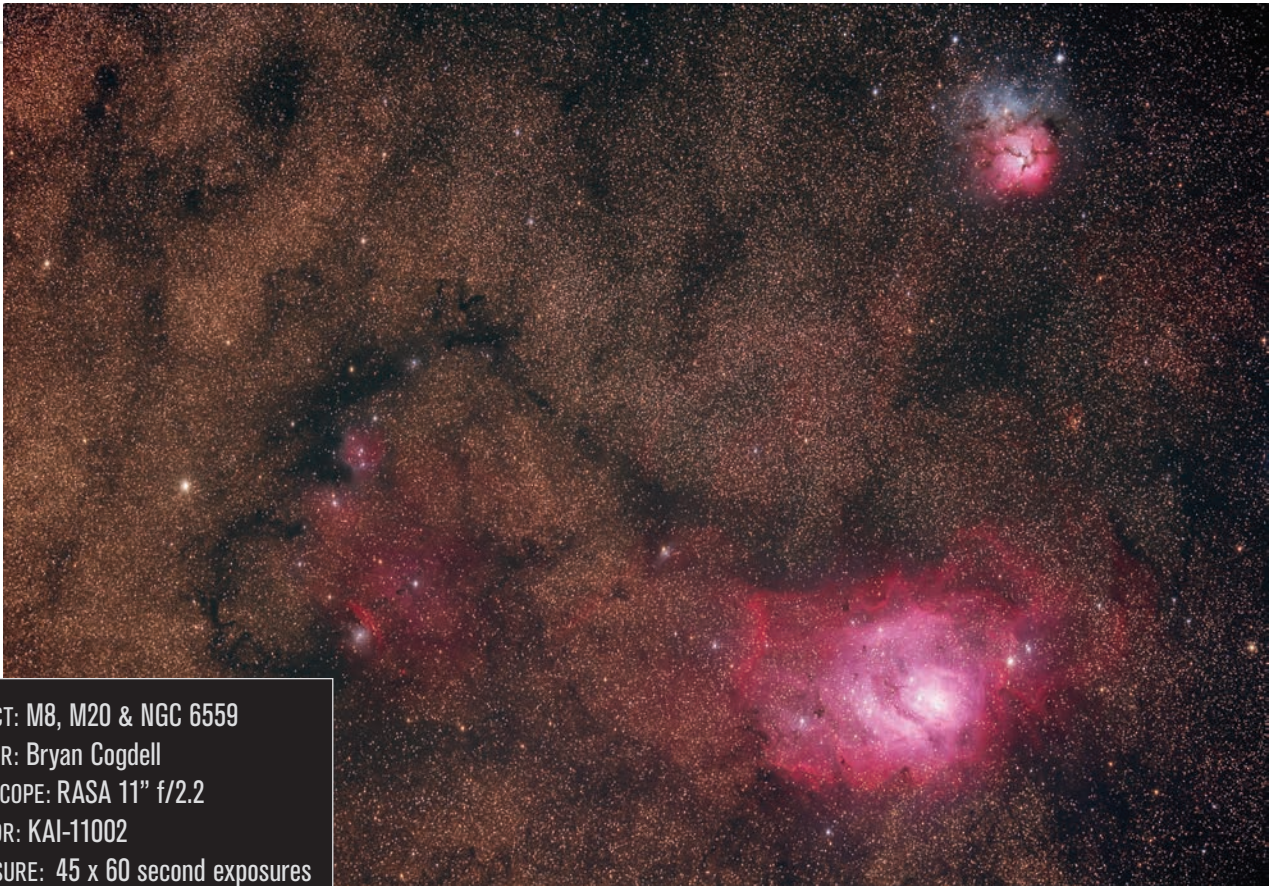

OBJECT: M8, M20 & NGC 6559
IMAGER: Bryan Cogdell
TELESCOPE: RASA 11" f/2.2
SENSOR: KAI-11002
EXPOSURE: 45 x 60 second exposures
DETAILS: Uncropped full frame,
without flat field calibration

OBJECT: NGC 1333 and surrounding region
IMAGER: Jimmy Walker
TELESCOPE: RASA 11" f/2.2
SENSOR: KAI-11002
EXPOSURE: 17 x 5 minute exposures

