

ASTRO

State-of-the-Art Instruments

*Dedicated to
Craftsmanship!*

PHYSICS

for Discriminating Astronomers

MACH1GTO

GERMAN EQUATORIAL
WITH GTOCP4
SERVO MOTOR DRIVE



Keypad Optional

Astro-Physics, Inc.
11250 Forest Hills Road
Machesney Park, IL 61115
Telephone: 815-282-1513
Fax: 815-282-9847
support@astro-physics.com
www.astro-physics.com

May 2018



ASTRO-PHYSICS

MACH1GTO GERMAN EQUATORIAL WITH GTOCP4 SERVO MOTOR DRIVE

ABOUT THIS MANUAL	3
<i>Mach1GTO</i> PARTS LIST	4
MECHANICAL FEATURES AND SPECIFICATIONS	5
INTRODUCTION	6
Why Polar Alignment is Important	6
ASSEMBLY INSTRUCTIONS	7
Before You Leave Home	8
Assembling and Disassembling the Two Axes	8
Additional Handy Tools	8
Select Pier, Tripod or Flat Surface Adapter	9
6" Eagle Adjustable Folding Pier (EAGLE6)	9
Berlebach Wood Tripod (AWTBER2)	9
Tripod Adapter (ADATRI)	9
Attach the Mount to the Pier Post or Tripod	10
Quick Start Summary – New Installations	10
SERVO Y-CABLE CONNECTION	11
External Y-Cable Connection	11
Internal Y-Cable Routing Connection	11
INTERNAL CABLE MANAGEMENT	12
Introduction to one of the Mach1GTO's more Innovative Features	12
Preparation	12
Cable Installation – the First Time	13
Disassembly and Subsequent Setups and Polar Alignments	14
A Few More Hints and Tricks...	14
Attach Mounting Plate	15
Notes on Attaching the Mounting Plates	15
Fixed Mounting Plate Options	16
Astro-Physics Dovetail Options	16
Losmandy D-Style Compatible Saddle Plates	17
Side-by-Side, Vixen Style and Other Plate Options	18
Assemble Counterweight Shaft	19
Optional 9.675" x 1.875" Counterweight Shaft	19
Attach Mounting Rings	20
UNDERSTANDING THE R.A. AND DEC. CLUTCH KNOBS	21
BALANCING THE TELESCOPE	22
Preliminary Balancing	22

Precision Balancing	22
Disengaging the Worm and Worm Wheel	22
Altitude and Azimuth Adjustments - Rough polar alignment	24
Fine Polar Alignment	27
Methods for fine polar alignment	27
Altitude and Azimuth Adjustments	28
Fine Altitude Adjustment	29
Fine Azimuth Adjustment	29
Using Software to Improve Pointing Accuracy	30
MACH1GTO AUTO-ADJUSTING GEARBOX - NO MORE WORM MESHING!	31
SOME IMPORTANT NOTES	32
MOUNT CARE, CLEANING AND MAINTENANCE	33
Care	33
Cleaning and Touch-up	33
Routine Mount Maintenance	33
Worm Wheel Maintenance	33
TROUBLESHOOTING, TIPS AND SUPPORT	34
Troubleshooting and Tips	34
Additional Support	35
APPENDIX A: DECLINATION AXIS BACKLASH TESTS	36
PulseGuide™	36
Dec. Backlash Test 1	36
Dec. Backlash Test 2	36
After Running Tests 1 and 2	37
Dec. Backlash Test 3	37
MaxImDL™	37
Step 1	37
Step 2	37
Step 3	37
APPENDIX B: MOUNTING PLATE FASTENER CHART	38

ABOUT THIS MANUAL

This version of the *Mach1GTO* Manual was prepared for the production run of mounts (serial # M10993 and later) that began shipping in March of 2018. Most of the information in this manual is applicable to all *Mach1GTO*'s that have been produced. Some of the information in this manual was simply not available when the first *Mach1GTO*'s left our production facility back in 2006. This includes information on newer accessories for the *Mach1GTO* that weren't available for the first production runs. We have also learned a few things through experience and the suggestions of our customers that have improved the information that is available in this manual.

You should also note that this manual is actually one component of a three document system. We have always had two manuals for each mount - one for the individual mount and another manual for the keypad that applied to all mounts. Starting in the summer of 2011, we further divided the mount manuals to allow us to present the GTO Servo Motor Drive System in greater detail. Like the Keypad Manual, the GTO Servo Manual is universal to all mounts that use the Astro-Physics GTO Servo Motor Drive System with the GTOCP4 Servo Control Box. [Note that the Keypad Manual will only be shipped if the optional Keypad is ordered.] This *Mach1GTO* Manual, on the other hand, will cover the *Mach1GTO*'s mechanical features and physical operations.

We suggest that all *Mach1GTO* owners adopt this manual along with the current GTO Servo Drive Manual for regular guidance with their mounts. The benefits of the improved information should easily outweigh the minor differences between mounts from earlier production runs and the current one. There will be a few things like the included serial cable, the Precision-Adjust Rotating Pier Base / Hi-Res Azimuth Adjuster and integrated RAPAS adapter that owners of older mounts will not have. In a similar fashion, owners of brand new mounts should be aware that some of the photos that were used in this manual are of mounts from earlier production runs. You may therefore see some slight differences between a brand new mount and a "first run" mount, but none of these were deemed to be significant, and hopefully, most have been noted in the text or captions. Older versions of the *Mach1GTO* Manual are available on our website.

As always, we highly recommend the Technical Support Section of our website for the latest information and for future updated versions of this manual.

A final note and an apology to our friends in the southern hemisphere. Many of the instructions in this manual are written entirely from the point of view of those of us in the northern hemisphere. Since descriptive terms like left and right are meaningless without a defined point of reference, we tend to use east and west to avoid ambiguity. The east and west sides of a German equatorial mount are, of course, reversed in the southern hemisphere. At one point, our thought was to always use phrases like the following: "...on the east side (west side in the southern hemisphere)..." This quickly became cumbersome and made the text more difficult to read. For simplicity, we decided to leave many of the explanations in their northern hemisphere framework. To our southern hemisphere friends: *We love you no less and apologize for this unintended slight.* We know, however, that you are all smart enough to make the necessary translation to "down under" appropriate instructions. Thank you for your understanding.

Note: Some photos may differ slightly from the current mounts that are shipping.

PLEASE RECORD THE FOLLOWING INFORMATION FOR FUTURE REFERENCE

Mount Serial Number: _____

GTOCP4 Serial Number: _____

Keypad Serial Number: _____

Purchase Date: _____

Mach1GTO PARTS LIST

- 1 Mach1GTO German Equatorial Head with Servo Drive Motors
- 1 GTO Control Box (Model GTOCP4) with control box-to-pier adapter (CBAPT)
- 1 13.675" x 1.125" Stainless Counterweight Shaft (M8084-A) with Machined Safety Stop (MSSKB)
- 1 Y-cable – R.A. portion is 24.5" long and Dec. portion is 40.5" length (SM1GYCR)
- 1 D.C. power cord set - 6' cable with power pole connectors (CABPP6), 18" cable with cigarette plug (CABPP18C) and 18" cable with ring connectors (CABPP18R) and clip (FPCLIP)
- 1 15' straight-through serial cable for computer connection (CABSER15)
- 1 1/4-20 Machined Knob Kit (M1485KBKIT)
- 1 CD containing PDF of Instruction Manuals
- 1 Hex key set
- Instruction Manuals and Registration Card
- All required fasteners

In order to fully assemble your mount, you will need some of the following items sold separately. Many of these items will be discussed throughout these instructions.

- **Telescope mounting plate:** Many choices to fit your telescope and observing needs. See detailed section later in this manual.
- **Pier or Tripod:**
 - 6" *Eagle* Adjustable Folding Pier (EAGLE6)
 - Berlebach Wood Tripod (AWTBER2) – requires Extension for Control Box Adapter (Q6280KIT)
 - Adapt to your own custom pier or tripod with our Tripod Adapter (ADATRI)
- **Counterweights:** 6 lb. (6SLCWT), 9 lb. (9SLCWT) and 14 lb. (14SLCWT) counterweights are available for the standard 1.125" diameter counterweight shaft. (5, 10 and 18 lb. weights are also available for the optional 1.875" diameter shaft – see below.) Generally, 85-100% of the weight of the scope, mounting plates and accessories is required in counterweights (more weight is required with larger diameter SCT scopes).
- **DC Power Source:** Portable rechargeable 12 volt battery pack or a power supply to convert your household AC current to DC current of 12 – 16 volts at a minimum of 5 amps. We offer a 13.8 volt 5 amp power supply (PS138V5A) and a variable volt 25 amp power supply (PSVPW25A). We recommend giving the mount its own power source and powering other devices and accessories from a separate power source or multiple sources. See the GTO Servo Drive System Manual for more information.

Many of these items will be discussed throughout these instructions. Several additional options are available:

- **Optional GTO Keypad controller** with 15' coiled cable. Hand-held computer to operate the mount without a PC and additional software.
- **Optional Counterweight Shaft:** 9.675" usable length x 1.875" diameter counterweight shaft (M1053-A) and safety stop (M12676) for use with 5 lb. (5SCWT), 10 lb. (10SCWT) and 18 lb. (18SCWT) counterweights. Handy for travel or if you already own one of our larger mounts which also use the 5, 10 and 18 lb. weights.
- **Right-Angle Polar Alignment Scope with LED Illuminator (RAPAS):** for quick and easy polar alignment.
- **Pier accessory trays:** A flat accessory tray with raised sides (TRAY06), a tray with eyepiece holes (TRAY06H), and two support bar options (TRAYSB or TRAYSB1) are now available to fit the 6" *Eagle* Adjustable Folding Pier, some sizes of the 6" portable pier and both tripods. They are handy and attractive places to keep your eyepieces and other astro-gadgets close at hand! They can also be used with the 8" Eagle Extension (EAGLE6E8) on other tripods.
- **Autoguiding Accessories:** Our 10 x 60 Vario-Finder with Guider Bracket Kit (1060VGKIT) is a highly recommended accessory for imagers. The GTOCP4 Control Box takes advantage of timed pulse guiding commands offered by most software guiding programs for best precision. See the GTO Servo Drive System Manual for more information. Additionally, various imaging and CCD based guiding configurations can take advantage of the *Mach1GTO's* autoguider port (RJ-11-6) which uses the industry standard SBIG ST-4 wiring setup.
- **PEMPro™:** PEMPro™ (available from CCDWare) gives you powerful tools to analyze and program your mount's periodic error correction firmware to achieve the best possible performance for your mount for dramatically improved guided and unguided imaging. PEMPro™ also contains the "Polar Align Wizard" for precision polar aligning using a quick electronic version of the traditional drift method. See the GTO Servo Drive System Manual for more information on PEMPro™.

MECHANICAL FEATURES AND SPECIFICATIONS

Construction	All CNC machined aluminum bar stock, stainless steel, brass. Stainless steel fasteners
Worm wheels - R.A. / Dec.	5.9" (150 mm), 225 tooth aluminum
Worm gears - R.A. / Dec.	0.705" (17.9 mm) diameter, special low-wear alloy
Axis shafts - R.A. / Dec.	2.36" (60 mm) diameter with 2" (51 mm) clear inside diameter
Shaft axis bearings - R.A. / Dec.	3.1" (78 mm) diameter, 2 per axis
Latitude range	0-70 degrees with or without the polar scope attached, engraved scale
Azimuth adjustment	Approximately 13 degrees (+/- 6.5 degrees from center)
Counterweight shaft	13.675" (346 mm) usable length x 1.125" (29 mm) diameter, incl. machined safety stop (MSSKB). Uses 6 lb. (6SLCWT), 9 lb. (9SLCWT) and 14 lb. (14SLCWT) counterweights. Weight: 4.1 lb. (1.8 kg) Optional counterweight shaft (M1053-A) available: 9.675" (246 mm) usable length x 1.875" (48 mm) diameter – 7.5 lbs. (3.4 kg); fits inside Dec. axis for transport and uses 5 lb. (5SCWT), 10 lb. (10SCWT) and 18 lb. (18SCWT) counterweights. Requires safety stop (M12676).
Weight	Total: 28 lb. (12.7 kg) R.A. axis / polar fork: 16.5 lb. (7.5 kg) Dec. axis: 11.5 lb. (5.2 kg)
Capacity	Approximately 65 lb. (30 kg) scope and accessories (not including counterweights), depending on length. Recommended for: Astro-Physics and similar fast refractors up to our 160 mm f7.5 StarFire EDF, 8-12" SCTs and 8-10" Maks. These are only guidelines. Some telescopes are long for their weight or very heavy for their size and will require a larger mount. Remember also that imaging requirements are more rigid than visual observation.
Instrument mounting interface	Reference the "Attach Mounting Plate" section of the manual.
Diameter of base	5.800" (147.32 mm) (portion that is inserted into pier top or ADATRI adapter)

For a complete listing of the servo control, power, and periodic error specifications, please see the GTO Servo Drive System Manual.

INTRODUCTION

The Astro-Physics *Mach1GTO* - Observatory Performance in a Small Package! This is the first, compact, light-weight mount that was designed for utmost portability while maintaining extreme rigidity and excellent tracking accuracy. No shortcuts were taken to achieve these goals. From the highly accurate fine-pitch gearbox to the precision machine tool bearings, to the innovative worm wheel / clutch design, this mount represents a new approach to this vital part of the overall imaging train.

The advent of modern CCD cameras and telescopes with high-resolution optics has placed greater demands on the ability of mounts to do their part to achieve precision tracking and guiding. At the same time, the mount should be easy to use with adjustments and setups that are straight-forward and accurate. We have done everything possible to eliminate the frustrations and limitations inherent in a lesser mount and so put the fun back into the hobby of amateur astronomy.

The *Mach1GTO* employs the reliable and sophisticated Astro-Physics GTO Servo Motor Drive System. The system uses precise Swiss DC servo motors under the control of the remarkable GTOCP4 Servo Control Box. The GTOCP4 is truly the “brains” of the system taking your wishes as expressed through a command input device like the Astro-Physics GTO Keypad or a computer, and translating them into actions taken by the mount.

The full range of command inputs is available from the optional GTO Keypad. This advanced keypad’s features allow you to slew automatically to objects in a wide range of databases, as well as any R.A. / Dec. coordinates. A large selection of common star names and non-stellar objects makes your selection a snap. Keypad operation is simple and intuitive.

Various computer software and our fully supported V2 ASCOM driver are available to make the connection between you, the astronomer, and the servo system versatile and straightforward. Details on the servo system and the various options for control software can be found in the separate Astro-Physics GTO Servo Drive System Manual.

The *Mach1GTO* has the strength, rigidity and sophistication to tempt you to permanently place it in a state-of-the-art observatory. However, its portability and ease of setup make it the finest mount of its size for remote use in your favorite dark sky location and even for travel to exotic observing locations around the world. This is the perfect mount for a small to mid-size refractor, Newtonian, Cassegrain or astrograph. Whether you enjoy visual astronomy exclusively or plan an aggressive astrophotography or CCD imaging program, this mount will allow you to maximize your night out under the stars.

In order to fully enjoy your first night out, we recommend that you familiarize yourself with the assembly and basic operation of the mount indoors. The temperature will be comfortable, the mosquitoes at bay, and you’ll have enough light to see the illustrations and read the manuals. Please take particular note of counter-balancing, use of the clutches and operation of the keypad controller.

Why Polar Alignment is Important

Polar alignment compensates for the Earth’s rotation. If you were to take a long exposure photograph with Polaris (often called the North Star) in the center of the field, you would discover that all stars seem to revolve around Polaris. This effect is due to the rotation of the earth on its axis. Motor driven equatorial mounts were designed to compensate for the earth’s rotation by moving the telescope at the same rate and opposite to the earth’s rotation. When the polar axis of the telescope is pointed at the celestial pole (polar aligned) as shown in the diagram, the mount will follow (track) the motions of the sun, moon, planets and stars. As a result, the object that you are observing will appear motionless as you observe through the eyepiece or take astrophotos.

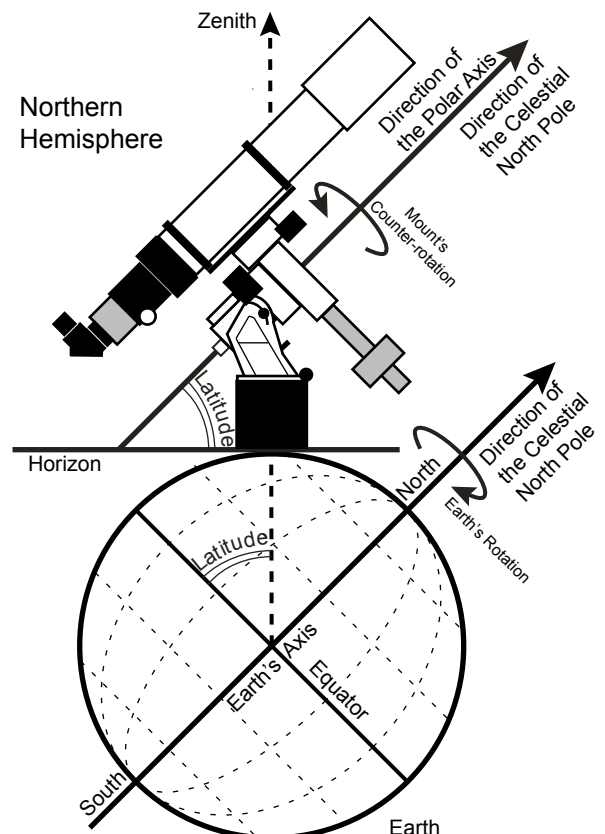

ASSEMBLY INSTRUCTIONS

Please read all instructions before attempting to set up your *Mach1GTO* mount. The *Mach1GTO* is very rugged, however like any precision instrument, it can be damaged by improper use and handling. Please refer to the following illustrations. The parts are labeled so that we can establish common terminology.

NOTE: The following terms and abbreviations are used interchangeably in these instructions:
 polar axis = right ascension axis = R.A. axis = R.A. housing = R.A.
 declination axis = Dec. axis = Dec. housing = Dec.

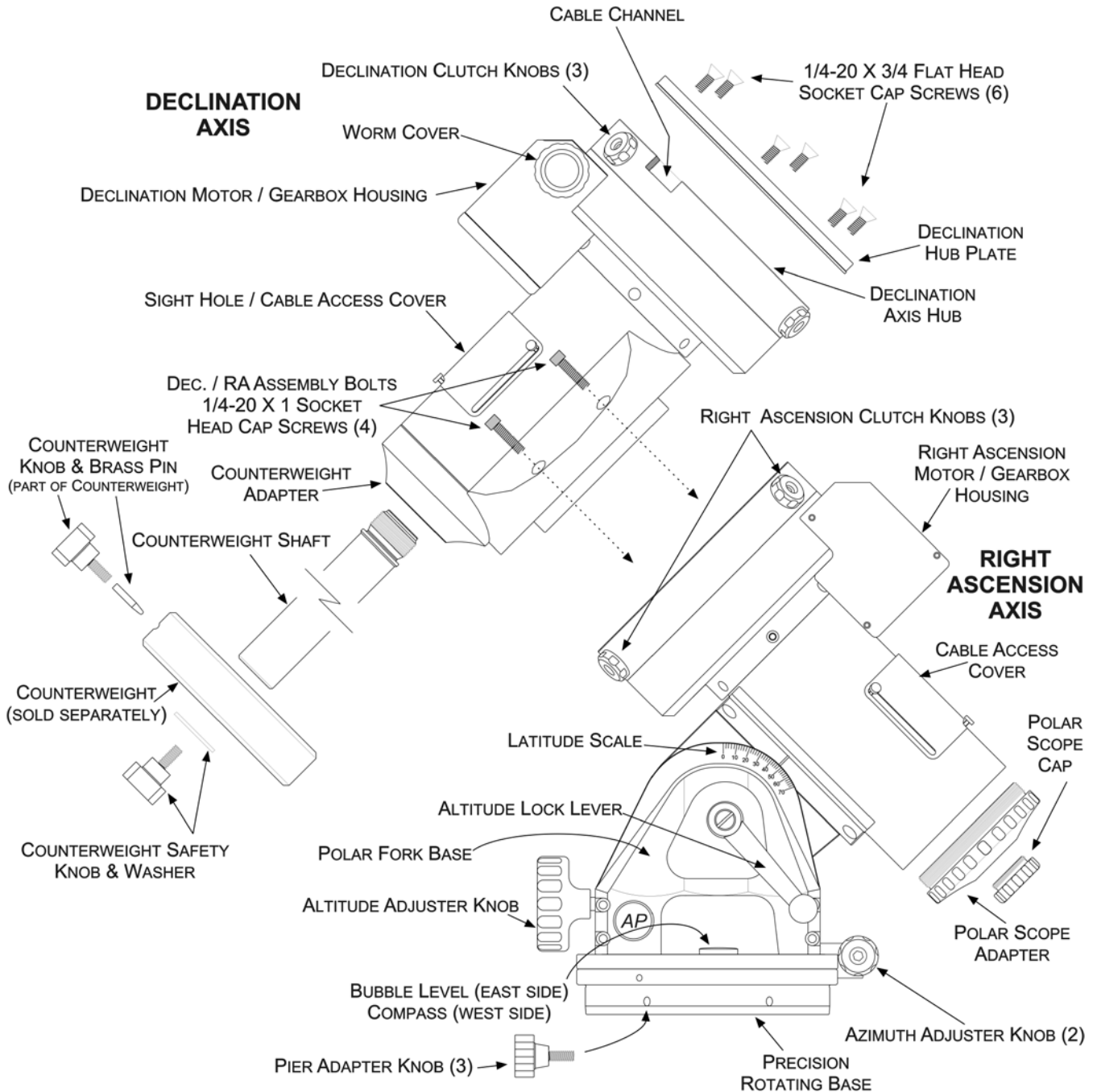

Before You Leave Home

Since most of us must set up our instruments in the dark, in the cold or while battling mosquitoes, a bit of pre-planning and organization is important. There are a few simple things that can be accomplished in the comfort of your home before heading outside. We would advise anyone to do a complete practice run from start to finish before venturing out into the field. This is especially important for those of you who may be new to German Equatorial Mounts.

Assembling and Disassembling the Two Axes

Because of its compact size and light weight, the *Mach1GTO* does not need to be disassembled for normal transport to and from an observing site. There will rarely be a need to disassemble the two axes. However, those of you who do disassemble your *Mach1GTO* for transport will need to be familiar with how the two axes are assembled and disassembled. When re-assembling your mount, we recommend that you fasten the R.A. axis onto your pier or tripod first. That way, you have a solid platform firmly holding on to your R.A. axis while you bolt the declination axis in place. The pier becomes your "extra set of hands."

The two axes assemble quite easily with the four 1/4-20 x 1" socket head cap screws shown in the Assembly Diagram on page 7. To properly line up the two axes, the R.A. axis must be positioned with the two pairs of screw holes on the east (2) and west (2) rather than on the north and south. In addition, the clutch knobs of the R.A. axis should be at 10 o'clock, 2 o'clock and 6 o'clock as shown in the photo. The four bolt holes will not line up in any other position. To turn the R.A. axis to this position, loosen the three clutch knobs and turn the axis. When in the proper position, retighten the clutch knobs for safety.



The declination axis is placed into its position in the R.A. axis with the counterweight adapter down, and the declination hub plate up as in the assembly diagram. Unlike the bigger 900GTO, 1100GTO, 1200GTO and 1600GTO mounts, the Dec. axis of the *Mach1GTO* must be straight and square to the R.A. mating surface when mounted. Don't try to tilt it into place as you would with the larger dovetailed mounts. Keep a hand on the declination axis to keep it from falling off until you have at least one of the screws loosely fastened. With the declination axis in place, insert and tighten the four 1/4-20 x 1" socket head cap screws.

Additional Handy Tools

In Your Accessory or Tool Box:

- Small torpedo level to level your scope when using the handy reference park positions, particularly during the daytime polar alignment routine outlined in your Keypad manual.
- Compass – Don't forget to know your magnetic offset when using a compass (there can be a large difference).
- Documentation – Physical copies of your mount, control box and keypad (if you have one) manuals as well as any other documentation that you received with your mount (or control box) or that you find in the Technical Support section of our website that may be useful.

On Your Smart Phone:

For the utmost of convenience, the following items can be downloaded to your smart phone, which you are likely carry with you everywhere.

- App(s) that allow your phone to be used as a level, inclinometer and compass. Don't forget to know your magnetic offset when using a compass since there can be a large difference.
- Astro-Physics Polar Alignment app – The longitude and latitude of your current site will display. Apps are available for iOS, Android and Windows.
- Download PDFs of all relevant and recent documents from the Technical Support Section of our website or you can link to our website if you have service at your observing site.

Select Pier, Tripod or Flat Surface Adapter

(purchased separately)

6" Eagle Adjustable Folding Pier (EAGLE6)

Assembly instructions for the 6" *Eagle* Adjustable Folding Pier are included with the pier. Please refer to those instructions for assembly, adjustment and leveling procedures. Your *Mach1GTO* will fit into the 6" *Eagle* Adjustable Folding Pier without any additional adapters. Simply set the mount into the open top of the pier and attach with the three pier adapter knobs included with the mount.

Position the tripod with one of the legs pointing roughly toward your pole. The counterweight shaft should be over this leg for balance safety.

You may wish to consider adding the **8" Extension for the Eagle Pier (EAGLE6E8)** to improve your viewing height comfort when using longer refracting telescopes.



Berlebach Wood Tripod (AWTBER2)

Open the legs of the tripod at the desired observing location. Note which direction is north (south if you are below the equator).

1. Position the tripod with one of the legs pointing roughly toward your pole. The counterweight shaft should be over this leg for balance safety.
2. Adjust legs to the desired height and spread them fully.
3. Lock in position with the hand knobs and make sure that leg clamps are tight. NOTE: Your tripod must be equipped with the Tripod Adapter (ADATRI) to mount the *Mach1GTO*. If you purchased your tripod from Astro-Physics, it came with this adapter already installed.
4. Attach the shelf to the central leg brace with the knob provided.

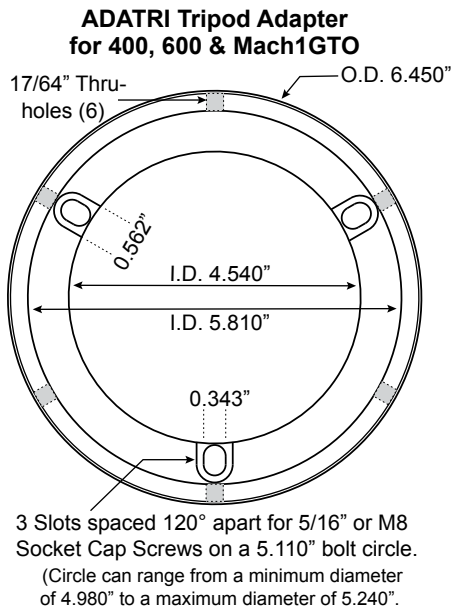

Tripod Adapter (ADATRI)

If you have your own custom pier or tripod with a flat surface on top, you can use our Tripod Adapter (ADATRI) for mounting the *Mach1GTO*. Current versions of the 900 Standard Pier Adapter (900SPA) and the Flat Pier Plate for ATS Piers (119FP) will also accept this adapter to use the *Mach1GTO* with 8" Astro-Physics and 8" ATS piers.

We also offer a separate adapter that can be used in conjunction with this Tripod Adapter in order to attach the Mach1 to a Losmandy Heavy Duty Tripod or a Losmandy Meade Tripod Adapter (LT2APM). See the website for details.

Attach the Mount to the Pier Post or Tripod

The pier adapter is already attached to your *Mach1GTO*. Starting in 2008, there are six attachment holes in the pier adapter base for positioning flexibility. You will use three of them (one every 120°) with the three provided pier adapter knobs. Simply set the mount into the pier post on your 6" *Eagle* Adjustable Folding pier, your Astro-Physics Portable Pier, or the adapter of your Adjustable Wood Tripod. Line up the through-slots on the pier or tripod with the tapped holes in the mount's pier adapter.

Hand fasten with the three pier adapter knobs. Imagers should further tighten with a hex key to ensure rigidity.

If you are attaching the Control Box Adapter (CBAPT) or a Tray Support Bar (TRAYSB or TRAYSB1) at the top of your pier or tripod, do that now.



Quick Start Summary – New Installations

This summary gives an outline of the workflow to have a successful first observing session. Enjoy!

1. Install and set up your control software and drivers. For all but the AP GTO Keypad, this can be done before you even take delivery of your mount.
 - a) Set up ASCOM and the drivers first
 - i) ASCOM Platform 6.3 (currently) - ascom-standards.org
 - ii) AP V2 ASCOM driver - <http://www.gralak.com/apdriver>
 - iii) FTDI driver - <http://www.ftdichip.com/Drivers/VCP.htm> See location of driver:
http://www.astro-physics.com/products/accessories/software/Serial_USB/FTDI_driver_find4.pdf
 - b) Install third party software (Starry Night, TheSkyX, MaxImDL, etc.)
 - c) Adjust software settings - follow the appropriate Workflow documentation that follows in this guide
 - d) If using the Keypad along with a computer, set the Keypad to AutoConnect=EXT and power cycle the mount in order to lock in the change.
2. Assemble the mount.
3. Balance the system.
4. Polar align the mount – at least roughly. (If using the daytime routine, move this step to after the mount is initialized. If using the RAPAS, do it before initializing.)
5. Place the system into a pre-defined AP Park position for initialization.
6. Power up the mount and connect with your primary control software. Use the primary control software to initialize the mount. Start out from the park position chosen in #5 above. Your other initialization settings will have been set already in step #1.
 - a) If using APCC, always start it and connect with it first.
 - b) If the AP V2 Driver is your primary control software, it must be started with a client program.
7. Connect other software that you will use with the mount.
8. After finishing your night's observing (or day's solar observing) it is best to park the mount into your chosen Park position using either the AP V2 driver or APCC, rather than Third Party software if you are using a PC for mount control.
9. Power down the mount.

SERVO Y-CABLE CONNECTION

External Y-Cable Connection

Early models of Astro-Physics mounts ran the motor servo cables externally. Although it is now possible to route the cables through the mount, there are times when it may be quicker or easier to leave them outside. We have taken care in designing our mounts to minimize the risk of cable snags. Nevertheless, it is important to properly position the cables when connecting the cables to the motor boxes. The photo at the right shows how the cable should be attached. Notice that the Dec. cable runs along the left side of the mount and has a gentle loop which allows free movement as the R.A. axis slews.



As you see in the two photos left and right, the GTOCP3 and GTOCP4 Control Boxes can be positioned in different locations depending upon your needs. It is also possible to add the 24" Servo Extension Cable (CABGTO24) if you wish to mount the control box even lower. Please see our website for details. (Note: Mount shown with GTOCP3 box.)



Internal Y-Cable Routing Connection

The Y-cable that connects your GTOCP3 or GTOCP4 control box to the servo motor gearboxes can be run either inside or outside the mount. The *Mach1GTO* doesn't really have anything that will catch the cables, but you still may want to run them inside. This is one cable that will not be run out through the declination axis hub. To insert the Y-cable, put the control box end into the sight-hole / cable access cover on the declination axis. Run it out through the R.A.'s cable access cover, and pull the shorter R.A. leg of the cable all the way through. If the polar scope adapter is removed, you can easily guide the control box plug out the cable access cover of the R.A. axis. Only the declination portion will be left inside the mount. Connect all three plugs. When you remove this cable, don't reverse the procedure; simply pull the declination leg on out through the R.A.'s cable access cover.



1. Feed control box end into Dec. Sight Hole / Cable Access Hole



2. Work control box cable end out through R.A. Cable Access Hole



3. Pull short cable leg through and connect to R.A. Servo Drive



4. Connect long cable leg to Dec. Servo Drive

INTERNAL CABLE MANAGEMENT

Introduction to one of the Mach1GTO's more Innovative Features

In years past, there was no such problem as cable management on astronomical equipment. The only cables would have been for the clock drive motor of the R.A. axis and maybe one for a drive motor attached to the Dec.'s tangent arm.

Today, we have added the cables that accompany film cameras, CCD cameras, autoguiders, multiple dew heaters, motorized focusers, and numerous other electronic accessories. Many modern imaging setups have cables going everywhere, and these cables can be a never ending source of problems and frustrations for the operator. Cables hanging from cameras can lead to images ruined by flexure. Cables can catch and snag as the mount slews, and are especially vulnerable when a German Equatorial Mount "swaps sides" to point at the other side of the meridian.

The *Mach1GTO* utilizes an innovative cable pass-through system that allows cables to enter and exit the mount's interior at several different locations.

1. The first of these is the hub end of the Dec. axis. Underneath the declination hub plate on the end of the declination axis are two cable channels. Cables passing through the hub get routed through one of these channels and on to their accessory. This is where imaging cables, dew heater cables and motorized focuser cables are most likely to be routed. Starting in 2011, these cable channels were enlarged to better facilitate some of the thicker cables used by some imaging systems.
2. The second point of egress is the sight hole / cable access cover on the Dec. axis. You can run the Dec. leg of your servo drive's Y-cable out through this opening. It is also a very convenient place from which to feed cables.
3. The third place to run cables in and out is the cable access cover on the R.A. axis. This is an especially useful place if you need to do a rough polar alignment each time you set up. It still allows the easy use of the polar scope.
4. Finally, for permanent installations or regular observing spots with marked pier / tripod positions (in other words, observing sites where you don't need the polar scope) the cables can be run out through the rear sight hole of the R.A. axis.

Which of these openings you use will depend on your particular situation. All of the openings and internal cable passages have a two inch diameter clearance that will accommodate a DE-9 serial plug with relative ease. It is certainly not required that you run any cables through the mount, but many of you will find this feature useful.

CAUTION! When running cables through your mount, you must keep in mind that they are there. To avoid problems from twisting, DO NOT EVER rotate the mount a full revolution or more (> 360°) while cables are inside. You can damage the cables. Operations where this might occur are balancing, re-greasing and other maintenance activities. GTOCP4 software versions VCP4-P01-11 and later will not allow the servo to rotate the axes beyond this limit. If you rotate the mount, do not forget to de-rotate it before continuing your activities.

Preparation

Your approach to cable routing will depend on two main factors: the particular cables you need to run and the degree of portability of your system. These factors lead to a couple of questions: Will the telescope's mounting plate remain attached to the mount between observing sessions? Is the mount often removed from the pier / tripod between sessions? Do you need to rough polar align each time you set up or can you set up and always be close enough to not need a polar scope? Or are you permanently mounted? Since everyone's situation will be a bit different, these instructions are more guidelines rather than specific "follow these to the letter or else" instructions.

If it is practical, you may find it most convenient to first set up your mount following the above instructions and get it pretty well polar aligned. The two axes must be assembled to run your cables. You won't do a final drift alignment yet, but you will want to get close. This is especially the case for those of you who are using a polar alignment scope like our RAPAS. You do not want to have the polar scope installed when the cables are being run through the inside of the mount or you might scratch the polar scope's objective. However, as you will see, there is a way to use your polar scope with the cables already in place, though this may not be possible in all cases. Do not have your telescope or mounting plate attached yet.

Remove the declination hub plate off of the declination axis hub by removing the six 1/4-20 x 3/4" flat head socket cap screws around its perimeter. Remove the polar scope from the R.A. axis if you are using one. Finally, remove the polar scope adapter (with polar scope cap) and raise the two cable access covers (one on each axis) to the open position. You are now ready to put in your cables.

Cable Installation – the First Time

Cables can be inserted either from the top (through the declination axis hub) or bottom (through the polar scope end of the R.A. axis), but the simplest way will usually be to insert the cables through the sight-hole / cable access cover on the declination axis. The easiest trick for inserting the cables, if you will be routing cables out through the declination axis hub (as is likely), is to turn the R.A. axis so the counterweight shaft adapter is pointing up and south and let gravity do the work. Always start by running the cables with the largest connectors first. Insert the telescope end of the cable into the sight-hole / cable access cover on the Dec. axis and guide it “down” and out the declination axis hub. Insert the opposite end in the same opening and guide it either out the R.A.’s cable access cover or out the bottom of the R.A. axis. If you are routing out the R.A.’s cable access cover, you can reach in the bottom of the R.A. axis to help you guide the cable end out the access hole.

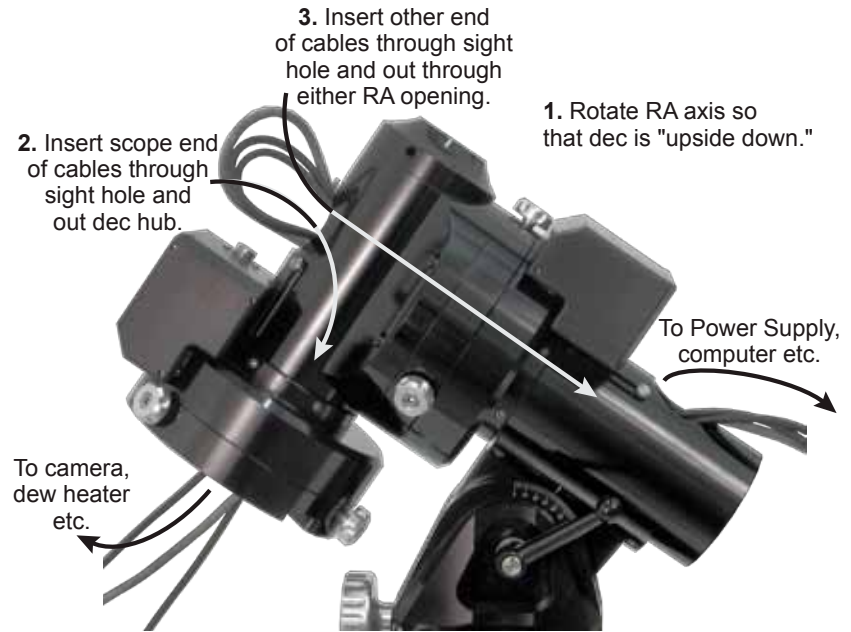

Mach1GTO Cable Insertion

When all the necessary cables have been run through the mount, turn the R.A. axis so that the mount is in its normal position with the counterweight shaft adapter pointing down and north. Adjust the amount of each cable that you will need sticking out through the declination axis hub to adequately reach its electronic device. When determining the length, be sure to run the cable through the cable channel and allow enough slack so that there will be no tension on the cable’s plug. Make sure you allow for focuser travel. Don’t allow too much slack, however, or you will defeat the whole purpose of hiding the cables inside the mount. Be sure that you route each cable through the appropriate cable channel side for the side of the telescope where it will plug in. Also, keep in mind any other places where you may wish to tie your cables like on the end of a mounting plate. Cables for CCD cameras should be tied off to the focuser or the very back of the mounting plate so that the weight of the cables does not pull on the camera causing image shift.



Once the cables are routed through the mount, and you have the proper amount sticking out the top of the declination axis hub, you are ready to replace the declination hub plate. Be sure that the cables are seated well in the two cable channels and that they are not being pinched by the plate. Put in two screws, one each on opposite sides of the plate and snug them down. Re-check that none of the cables have been pinched and then tighten the two screws firmly. If you are using the FP1800, the RP900 or the Q4047 (with DOVE08-*discontinued*) as your telescope mounting plate, install it now using the four provided screws in the remaining four holes. If you will be using one of the other telescope mounting plates (FP1500, DOVE15, DOVELM2 (*discontinued*), DOVEDV10 or DOVELM162), first install the remaining four screws from the declination hub plate, and then install the mounting plate with the correct fasteners that were provided.

Where the cables emerge (R.A. cable access hole or bottom of R.A. axis), make sure that nothing will be hanging or pulling on any of the cables. You may wish to bundle the cables together and tie them off to a tripod leg or pier strut to eliminate potential tripping hazards. Run them carefully to wherever they will be plugged in (laptop, heater controller etc.). If you have run the cables out the R.A.’s cable access hole, replace the polar scope adapter and polar scope cap. Do NOT over-tighten the polar scope adapter. You can also partially close the sight-hole / cable access cover on the Dec. axis and the cable access cover on the R.A. axis at this time. They can’t be closed all the way with cables routed through them but they can be closed enough to keep most dirt and dust out.

Disassembly and Subsequent Setups and Polar Alignments

Once you have gone to all this effort, you won't want to undo everything for relatively simple tear-down and set-up situations. And you won't have to! The degree to which you must disassemble the cabling depends on the degree to which you must break down the mount. If you need to disassemble the mount for airline travel, you will unfortunately need to undo everything. If you simply move your entire assembly in and out of the garage on its pier or tripod, you will hardly need to take anything apart. Most of us are somewhere in between. Disassembly steps are basically the reverse of the installation steps above and really don't need further elaboration. The main point is that you will want to avoid complete removal of the cables that involves taking off the declination hub plate if that is possible for your situation.

The real question is: how can subsequent setups be done easily, and how can a person polar align with all those cables in there? Fortunately there are two easy solutions. First, if you regularly need to use your polar scope and you are only running a couple of cables through the mount, just make sure that your cables were run out the R.A.'s cable access hole. If you use this feature, you can insert and use the polar scope without any problem. (You may need to tug lightly at a cable to get it out of the line of sight when aligning.) The cables can simply be left in place and wrapped around the mount for most transport and storage situations. Just take care not to pinch the cables anywhere or to strike a connector on the exterior surfaces of the mount, which could cause a scratch. Then, set up the mount with the cables already in place.

But what about polar alignment if the cables have been run out the bottom of the R.A. axis or if there are very many cables? Simple! Set your mount up on its tripod or pier, but don't tie off or hook up any of the cables from the bottom of the R.A. axis yet. Now, open the sight-hole / cable access cover on the declination axis. Push the cables up from the bottom of the R.A. axis with one hand and hook them with a finger through the sight-hole. Pull the bottom part of the cabling out through the hole and hang the cables out of the way. Insert your polar scope adapter to rough polar align (don't over-tighten), and then put in a polar scope to get a good polar alignment. When you are as close as you can get, pull off the polar scope and adapter, and reinsert your cables through the sight-hole / cable access cover. You are now ready to tie them off, plug them in and go!

A Few More Hints and Tricks...

- **Polar Scope Aid** - If you have cables routed through the mount and need to use a polar alignment scope, obtain a thick vinyl report cover from an office supply store (I recommend black). Cut the vinyl sheet to a 7" x 9" size and slightly trim off the corners so that they do not catch or dog-ear (bend). Roll up the cover into a tight tube 9" in length and insert it into the Dec. sight-hole and down over the polar scope. When you release the rolled-up cover, it will spread open and push the cables outward, allowing the polar scope to sight on Polaris without blockage. Note: While you have the polar scope in place, the cables will need to exit via the R.A. cable access port.
- If you need to remove a cable completely from the mount, mark the point where it emerges from the cable channel in the declination access hub. Wrapping the cable at that point with a small piece of colored electrical tape works well. That way you won't need to re-measure to position the cable properly.
- Always tie off cables for CCD cameras to the focuser so that the weight of the cables doesn't cause movement (flexure) in the imaging system over a long exposure.

...and Recommendations

- **Outdoor Storage** – If you have a mount that is left outside for extended periods covered by a tarp or scope cover, then it is highly recommended to remove the GTOCP4 and Keypad and take them inside to a safer environment. Tarps and covers cause significant moisture build up from condensation unless steps are taken to mediate the problem. Often low wattage light bulbs or fans are used to reduce condensation.

Please feel free to contribute hints and tricks of your own for future editions of this manual. At Astro-Physics, we know that our customers come up with some clever solutions! E-mail your suggestions to support@astro-physics.com.

Attach Mounting Plate

(purchased separately)

Several mounting plates (also called cradle or saddle plates) are available for the *Mach1GTO* mount. If you own more than one instrument, you may need more than one plate, or you may wish to use one of the dovetail saddle plate options with more than one male dovetail sliding bar. Attach your mounting plate with the screws provided with the plate. It is important to use the proper screws, please refer to the information sheet entitled "Mounting Plate Fastener Chart." This chart is available at the end of this manual and in the Technical Support section of our website.

Notes on Attaching the Mounting Plates

Three of the components listed below have six mounting holes that match the six screw holes that hold the declination hub plate onto the hub of the *Mach1GTO*'s Dec. axis (FP1800, 900RP and Q4047). For ease of assembly, we recommend that you use only four of these holes to mount your plate. Remove four of the screws that hold the declination hub plate in place. They will be replaced by the four screws that hold the mounting plate down. The remaining two can then still hold the declination hub plate in place on the Declination Axis hub while the mounting plate is being attached. The four remaining holes are more than adequate to hold the plate securely on the mount. It really doesn't matter which four you choose, but the two screws left to hold the declination hub plate in place should probably be opposite each other. You may also remove the declination hub plate if you wish for the FP1800 or Q4047, but you will slightly reduce the size of the cable channels.

You will also notice that in addition to the four holes that make up the inside pattern on the declination hub plate, there is an extra hole that matches an extra hole found in two of the Losmandy style plates (DOVEDV10) and DOVELM162). This fifth hole is not used if the four regular holes are in use. However, if you lose a mounting screw, it can be used in place of the two normal holes on that end of the plate to make a very solid 3 point attachment (turned 90° from the shown optical axis position).

While there is no required orientation of the mounting plate, we have found the two orientations in the photo at right to work very well. The advantage to the pictured orientations is primarily in the ease of working the clutch knobs, and in providing the easiest routing for cables. Note that your declination hub plate may not be oriented properly for this arrangement. If not, simply remove and rotate it into this position with respect to the clutch knobs and cable channels. As pictured, the two cable channels are at 12 o'clock and 6 o'clock. The clutch knobs are at 3, 7 and 11 o'clock. (The extra hole mentioned above is at 9 o'clock.) The optical axis for a plate with the four-hole pattern is directly over the cable channels. Plates with the six-hole pattern are rotated a bit to allow the attachment bolts to clear the cable channels.

Mounting Plate Orientation

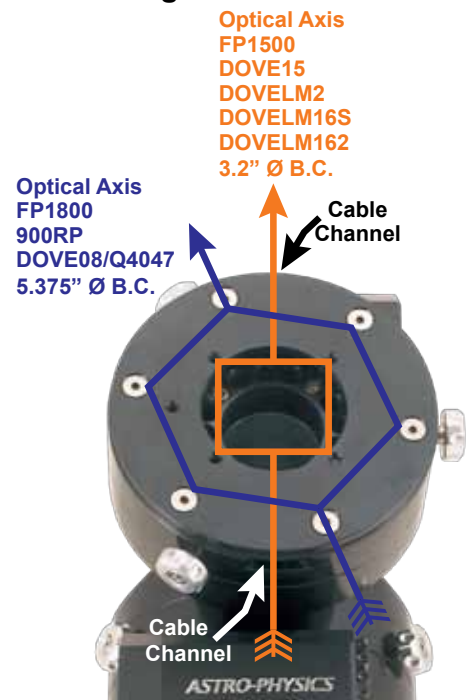

Fixed Mounting Plate Options

15" Flat Mounting Plate (FP1500)

This plate is 15" long by 4.6" wide by 0.5" thick. Two pairs of keyhole slots that measure 3.2" between centers are provided for the instrument mounting rings. The pairs are 13.75" apart. You can drill additional holes to suit your needs. This plate also fits the 400, 600E, 900, 1100, 1200 and 1600 German Equatorial mounts.



The 15" Flat Mounting Plate's mounting ring hole spacing of 13.75" allows the use of the 15" Dovetail Plate (DOVE15) on top of your instrument as an accessory plate.

Attach this plate with four 1/4-20 x 5/8" socket head cap screws

15" Ribbed Mounting Plate (900RP)

The finished plate is 0.75" thick, 15" long and 6.5" at its widest point. The width of the plate tapers to 4.75". A pair of keyhole slots that measure 3.2" between centers are provided at each end. The distance between these pairs of holes is 13.75". Due to the ribbed structure, you may not be able to drill additional holes to suit your mounting rings. The plate weighs 2.3 lbs.

Attach this plate with four 1/4-20 x 1 1/4" flat head socket cap screws. Leave two screws in the Dec. hub's top plate. (see below) Note that the plate is asymmetrical. In most cases, orient the plate so that the long end points toward the sky. You can also turn the plate in the other direction to balance your scope.

Like the plates above, the 900RP's mounting ring hole spacing of 13.75" allows the use of the 15" Dovetail Plate (DOVE15) on top of your instrument as an accessory plate.



Astro-Physics Dovetail Options

15" Astro-Physics Dovetail Saddle Plate (DOVE15) for 15" Sliding Bar (SB1500)

The 15" version of our dovetail plate is suited for the 130 f/8 StarFire EDT, 130 f/6 StarFire EDF, 130 f/6.3 StarFire GT/GTX, Takahashi scopes and other instruments of similar size. The two knob assemblies each feature a brass pin with a tapered end to hold your sliding bar firmly without marring the aluminum. Use with the 15" Sliding Bar (SB1500), which is sold separately. It also makes a great accessory plate when used with either the 900RP, the FP1500, the FP1800 (with rings mounted to inside holes), the SBD16 or another DOVE15.

NOTE: This plate will not accept Vixen style plates (sliding bars) like the Losmandy V series. The Vixen specification is slightly narrower than our long established Astro-Physics 15" specification and has a much less angled bevel to the dovetail. This dovetail saddle will not adequately clamp onto the smaller Vixen style plate (sliding bar). If you have a Vixen or V-style dovetail plate on your instrument, please use our 10" Dual-style Dovetail Saddle (DOVEDV10).



Attach with four 1/4-20 x 1/2" flat head socket cap screws.

Losmandy D-Style Compatible Saddle Plates

The following dovetail saddle plates are for the Losmandy D-style dovetail plates (sliding bars). Along with the standard dovetail plates made by Losmandy, additional D-style options are now available. These include two sliding bars made by Astro-Physics: (SBD12 and SBD16), and two Astro-Physics side-by-side bars: (SBD13SS and SBD16SS). For those of you who have scopes with the Vixen style or V-style sliding bars, we also produce the 10" Dual-style Dovetail Saddle (DOVEDV10) and the D- to V-style Adapter (SBD2V).

8.5" Dovetail Saddle Plate (DOVELM2) (Discontinued)

This Astro-Physics plate attaches to the 400, 600E, 900, 1100, 1200, 1600 and *Mach1GTO* mounts. If you already own one of the Losmandy DAP series (fits Astro-Physics refractors), DC series (for Celestron 8" 9.25" or 11" SCTs) or DM series (for Meade 8" and 10" SCTs) plates, you should consider this plate or the longer DOVELM162. For larger size SCTs we recommend the Easy-Balance DOVELM162 – see below. This is also the perfect saddle plate for our SBD12 Dovetail Sliding Bar.

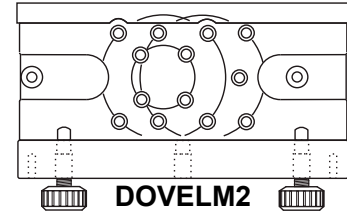

10" Dovetail Saddle Plate for both D-style and V-style Plates (DOVEDV10) (replacing DOVELM2)

This 10" Dual-style Saddle Plate fills the need of customers who have multiple scopes. Often times the smaller scopes are outfitted with Vixen V-style dovetail plates; whereas, the larger scopes have the more stable Losmandy D-style plates. The DOVEDV10 is the perfect solution as the best of both worlds.

It is a very robust dovetail saddle that will securely attach all your scopes to the mount. The clamp design provides the strongest possible lock for both style plates. The saddle has three locking clamps. Using all three will provide extra security, while using one of the end clamps along with the center clamp will allow shorter dovetail plates to be secured.



The clamping blocks grip your dovetail plate firmly. Springs keep the blocks in an open position until you tighten the knobs. The unique design of the clamping blocks ensures that they remain properly aligned with no need for additional guide pins and the brass washers on the knobs allow firm tightening without binding.

The saddle has the convenience of the Astro-Physics tilt-in feature applicable to both style plates. It has additional attachment holes so that the saddle can be shifted forward or backward, depending on whether you are balancing a front-heavy or back-heavy scope. In addition to D-style plates, it matches well with the Astro-Physics 15" V-style Plate (SBV15).

16" Easy-Balance Dovetail Saddle Plate for Losmandy D-style Plates (DOVELM162)

This Astro-Physics plate was introduced in February, 2009 and in mid-2010 we added the center clamp for even greater versatility. The DOVELM162 provides a multitude of mount attachment options, and was specifically designed to meet the balancing demands of "back-end-heavy" instruments like SCTs and Ritchey-Chrétiens, especially those with heavy imaging gear hanging off the back!

This plate has small knobs to avoid interference with the declination hub, but the knobs have cap screws in the ends that accept a 3/16 hex wrench for extremely secure clamping of your instrument. Additional features include ribbed structure underneath to reduce weight and tapped 10-32 holes in the side for cable attachment.



Note that the bolt-hole patterns are marked with scribe cuts. Attach this plate with four 1/4-20 x 1" socket head cap screws. Holes along the center-line of the saddle plate are for use with the larger 900, 1100, 1200 and 1600 series of mounts and are not used with the *Mach1GTO*.

Side-by-Side, Vixen Style and Other Plate Options

In general, we recommend side-by-side configurations more often for our larger mounts. However, the *Mach1GTO* can handle a pair of smaller instruments in a side-by-side configuration. A nice pairing for a versatile visual setup might be a small wide field refractor along with a smaller-sized Maksutov Cassegrain for high-power viewing. We never recommend using a side-by-side mounting as a guidescope / imaging scope setup due to the possibility of differential flexure.



13" and 16" Side-by-Side D-style Plates (SBD13SS & SBD16SS)

These plates will fit into any D-style compatible plates and will accept the DOVELM2, the DOVEDV10 or the DOVELM162 as the instrument saddle plates for each scope. The 13" plate allows optical axes to be placed on 9.5" (250 mm) centers, and the 16" plate allows instruments on 12.5" (318 mm) optical centers.

10" Dovetail Saddle Plate for both D-style and V-style Plates (DOVEDV10)

Please see the description on the previous page. This saddle can use our 15" Vixen V-style Wide Dovetail Plate (SBV15).

12" Vixen Dovetail Converter (SBD2V)

This 12" plate fills the void for those customers whose telescopes use the Vixen-style mounting plate including the Losmandy V-style. Now there is no need to replace your existing Vixen-style bar, rings, or clamshell to accommodate your Astro-Physics mount.

The top portion is a female plate that accepts Vixen-style bars. In order to retain the tilt-in feature of the dovetail, the sliding bars must have an approximate width (at the widest point) between 1.65" (42 mm) and 1.8" (45 mm) and they must have a 75 degree bevel on each side. The bottom portion is a standard D series dovetail that will fit into any of our D series compatible saddle plates.



Please note that we are not great fans of the Vixen style design. It is our belief that the 75 degree bevel does not provide an adequate safety margin for the clamps. We have not tested all plates that are currently available on the market. We recommend you check your plate for a good fit in this saddle without an instrument attached! Also, note that the top portion of this plate is NOT designed to be used with our SB0800, SB1000 or SB1500 sliding bars.

15" V-style Dovetail Plate (SBV15)

This 15" long Vixen V-style dovetail plate is designed to add maximum strength and rigidity to your scope setup. It uses a wide attachment surface with the 2.362" (60 mm) side-to-side hole-pattern of Astro-Physics and many other scope rings, along with the universality of center slots.

Though it was designed to be used with the 10" Dual-style Saddle Plate (DOVEDV10), the SBV15 can be used with all Vixen V-style OEM systems.



The plate can also be used as an accessory plate by attaching it to the top of rings. This will allow affixing a variety of accessories using V-style adapters.

Other Mounting Plate Options

Additional mounting plate options including custom plates may be available from other sources. The hole patterns for the declination hub are shown on the illustration on page 15.

Assemble Counterweight Shaft

IMPORTANT: Always attach the counterweights before mounting the telescope to the cradle plate to prevent sudden movement of an unbalanced tube assembly, which may cause damage or injury. Remember counterweights are heavy and will hurt if they fall on your foot.

1. Thread the counterweight shaft onto the Dec. axis. **Be careful to not cross-thread the shaft in the adapter!**
2. Remove the Safety Stop from the base of the counterweight shaft, if it is installed. Add sufficient counterweights (purchased separately) to the counterweight shaft to balance the telescope you intend to use. Loosen the counterweight knob and hold the counterweight with the knob pointing downward so that the brass pin will move from the center opening allowing the counterweight to slide into position. Always use two hands to attach or move the counterweights on the shaft. It is advisable to have the counterweight knob pointing down toward the pier. This will minimize the chance of accidentally loosening the counterweight during the observing session.
3. **FOR YOUR SAFETY: Reattach the counterweight Safety Stop to the end of the counterweight shaft.** This will help to prevent injury if someone accidentally loosens the counterweight knob.

NOTE: A firm tightening of the counterweight knob will not damage the surface of the counterweight shaft. The pin that tightens against the stainless counterweight shaft is bronze.

Optional 9.675" x 1.875" Counterweight Shaft

The optional 9.675" usable length x 1.875" diameter counterweight shaft offers some additional capabilities and considerations. The shaft installs in the same way as the standard shaft, but uses the larger Safety Stop (M12676) at the end of the shaft. For safety, you **MUST** use this safety stop! There are two main reasons why a person might choose the optional counterweight shaft over the standard 14.5" x 1.125" shaft:



1. Owners of 900, 1100, 1200 or 1600 series mounts might prefer to purchase the optional shaft because it uses the same 5 lb. (5SCWT), 10 lb. (10SCWT) and 18 lb. (18SCWT) counterweights that those bigger mounts use. These counterweights have larger 1.875" diameter center holes. Please note that this shaft weighs in at a hefty 7.5 lb., including the safety stop.

2. Owners who plan to use their *Mach1GTO* for long-distance travel may wish to purchase this shaft for a more compact fit in a travel case. The 9.675" shaft was specifically designed to fit inside the hollow declination shaft and screw into the counterweight adapter from the back side. When fully screwed into the adapter, and with the Safety Stop in place, the whole thing only protrudes about 3/4" from the face of the declination hub plate. To prevent you from accidentally getting the shaft stuck inside the Dec. axis, we added a socket head screw to the end of the shaft. Simply use your 1/4" hex key to break it loose if needed.

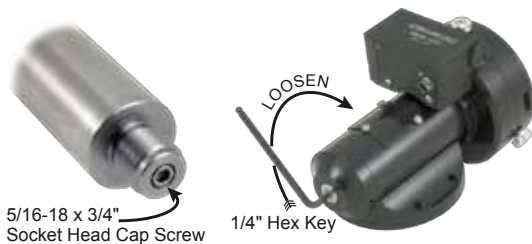

Keep in mind that the combined weight of the equatorial head and shaft will be 36 lbs. not counting the GTOCP4 control box, keypad, cables or the travel case itself. With the mount's two axes separated, and the shaft thus stored, it will all fit neatly into a case that should fit into an overhead luggage compartment, but you still have to be able to lift it up that high! You must also be aware of all rules and regulations regarding weight limits and allowable case sizes, not to mention potential security problems. Please do your homework before trying to take a trip with your valuable astronomical equipment. We have designed the mount to be portable, but we cannot guarantee that you will be allowed to carry it with you.



One final caution: This is a “really cool” feature, but remember, you will need to remove the mounting saddle to take advantage of this capability. It will be great for long-distance travel, but you may not want to store the shaft inside the Dec. axis for trips to and from your local dark site.

Attach Mounting Rings

(purchased separately)

If this is your first session with your new mount, you may wish to read the “Understanding R.A. and Dec. Clutch Knobs” section before attaching your telescope. This will give you an idea of how the clutch knobs feel and function.

Flat and ribbed plates: constructed with keyhole slots at the location where your mounting rings attach. This feature enables you to partially loosen the screws on your rings just enough to insert them into the larger part of the keyhole, then slide the rings to the narrow part and tighten them with a hex key. You can even accomplish this with the rings on the scope, although this maneuver may be difficult to accomplish with a large, heavy instrument.

We prefer this keyhole method to the standard way of completely removing the screws and possibly dropping them in the grass.

Astro-Physics or Losmandy Dovetail Plates: Attach the mounting rings to the male dovetail plate (sliding bar).

UNDERSTANDING THE R.A. AND DEC. CLUTCH KNOBS

WARNING! *Be careful when moving the mount with the clutches. It is possible to catch cables or fingers between the clutch knobs and the motor/gearboxes if you are not careful!*

CAUTION! *When moving the mount via the clutches, the servo is not involved, and therefore is not keeping track of the axis' positions. Bear in mind that internally run cables can be twisted and damaged if you are not keeping track of, and accounting for movements made using the clutches. If cables are run internally, you do not ever want to rotate an axis more than 360°. If you rotate the mount, do not forget to de-rotate it before continuing your activities.*

What do they do?

The three R.A. and three Dec. clutch knobs have the function of connecting the R.A. and Dec. axes to their respective drive worm wheel gears. Their function is progressive, from light tension (axes free to move – as required during correct balancing of the telescope) to a completely “locked up” state. Please note that the clutches have no bearing whatsoever on the worm drive itself. They are simply the mechanism that marries the worm wheel to the axis.

How can you find out what they really do?

As shipped, all *Mach1GTO* mounts have all three R.A. and Dec. clutch knobs firmly hand tightened. This will give you a good idea of the maximum tightness (clutch action) that can be achieved by hand effort alone. At this point, you must bear in mind that for optimum performance all three clutch knobs on each axis (R.A. or Dec.) should be tightened evenly with the same tension (i.e. all three half tight, all three fully tight, etc.).

In order to feel the effect of the clutch knobs, you may wish to assemble your mount with the mounting plate and counterweight shaft. Do not put scope and counterweights on at this stage. With the above assembly (with the clutch knobs firmly hand tightened – “as shipped”), you can feel the amount of force needed to move each axis by hand. Grab each end of the telescope mounting plate and move it with a backward and forward movement of the Dec. axis. You will feel considerable resistance to this motion. Perform the same operation on the R.A. axis by moving the counterweight shaft backward and forward. With a well-balanced telescope, the above tightness of the clutch knobs will be sufficient for all normal conditions of use.

Now, mount up and balance your telescope so you can “feel” what this resistance in R.A. and Dec. (movement backwards and forwards) is like when you make these motions from the eyepiece end of your telescope as you would during normal use when slewing (pushing) by hand to acquire an astronomical object within the field of view of your finder or scope.

How tight can the clutch be and can you do any damage by over-tightening them?

These clutches can be tightened as much as needed. There is no danger of over-tightening. You will see that each clutch knob has a 3/16” hex socket for tightening with an Allen key. Using the provided hex key you can lock up the clutches so that only the worm drives are able to move each axis. You should **NOT** attempt to push your scope by hand against this “locked up” resistance, or undue stress will be placed on the worm wheel, worm gear and bearings. Also note that locked up clutches provide no safety factor for your equipment should you hit the pier!

Most users will never need to use a hex key on their *Mach1GTO*'s clutches, but if you are heavily loaded, if your system is out of balance, or if you are doing critical long exposure astrophotography, you may wish to have the extra clutch tightness. As a general rule, if you have a big scope (6” refractor or 10” SCT) with all the accessories, you will need more clutch tension than a 4” or 5” scope.

My clutches don't seem to loosen up the axes as much as my 900 or 1200 mount's clutches when I loosen the knobs. Is this correct?

The *Mach1GTO* uses a different clutch system, and it also uses a different bearing system for the free rotation of the axes. It will feel stiffer than the 900 or 1200 series mounts.

You should also be aware that the clutch knobs on the *Mach1GTO* have spring loaded tips that may still be applying pressure to the clutches, even though the clutch knobs feel loose. Back the clutch knobs off by at least six or eight full turns to more fully disengage the clutches.

BALANCING THE TELESCOPE

To achieve the best performance from your mount, your telescope should be well-balanced. This is more important for imaging setups than for visual setups since greater precision is required for guiding. Those who are setting up for visual use or casual imaging need only be “adequately” balanced, as the mount’s drive system is very robust.

Common sense dictates that you want to begin the balancing procedure with your setup counterweight heavy so that the scope does not suddenly leap from your hands and spin around into the pier. As long as the counterweight is down, sudden movements of the Dec. axis cannot cause a damaging mishap. You will want to perform the balancing with the scope set up exactly as it will be used. Eyepieces, diagonals, finder scopes, cameras, guiders, etc. should all be in place before you begin.

Preliminary Balancing

1. With the counterweight shaft down and the scope pointing toward the pole (Park 3), loosen the Dec. clutch knobs (about 3 to 4 full turns) and feel which way the scope’s weight is offset. Placing a hand on each end of the scope and lifting back and forth will give you a good feel for balance. Slide the scope (in its rings or via the dovetail) until it feels balanced, then point the scope to the north again and tighten the clutches.
2. Next, loosen the R.A. clutch knobs (about 2 to 3 full turns) and, while holding the counterweight shaft, move the axis into a horizontal orientation. You will probably need to rotate the Dec. axis a bit so that it also assumes a horizontal orientation. Place a hand at the end of the shaft and on the scope and, lifting back and forth, make counterweight adjustments to equalize the balance as best possible.

This degree of balancing will be sufficient for those who wish to have some fun doing visual observing with family and friends. If you are planning to do long-exposure, deep-sky imaging, then you’ll want to refine the balance. The steps below will walk you through precision balancing.

Precision Balancing

Remember that dangling cables will dramatically change balance and create guiding problems, so you’ll want to be sure that all cables are carefully secured and not dragging before you proceed with balancing. Ensure that your focuser is in its focused position, the dew shield extended and the dust cap removed. The following three recommendations will increase guiding performance.

1. *Slightly* offset balance to the counterweight side of the R.A. axis. When the axis is perfectly balanced horizontally, then offset the weight just enough to start motion *slightly* downward on the counterweight side.
2. *Slightly* offset balance to the camera side of the Dec. axis. When the axis is perfectly balanced horizontally, then offset the scope just enough to start motion *slightly* downward on the camera end.
3. The counterweights should ride high on the counterweight shaft. It is best to add counterweights and slide them to the top of the shaft with the heaviest at the top and then use the smallest weight to perform the precision balancing. The reason for this is called “Inertial Moment Arm”. Sliding less weight down the shaft will balance the scope, but will greatly increase the moment arm force; that is to say, it will require a much greater torque to start the axis rotating. (Think of a tightrope walker using a long rod to stabilize his balance.) This is a very important consideration when you are trying to do precise guiding. See *illustration above right*.

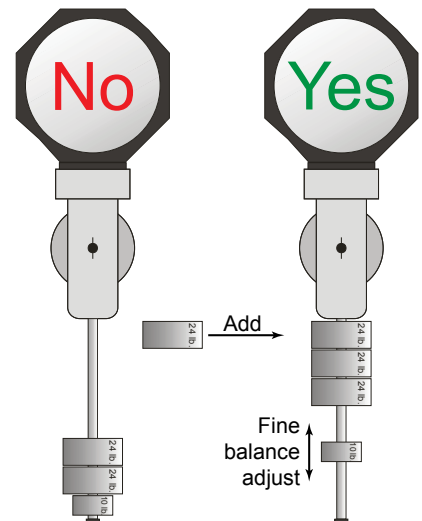

Disengaging the Worm and Worm Wheel

The new motor / gearbox design allows complete disengagement of the worm from the worm wheel allowing the axis to turn freely for careful balancing. It is important to begin with the scope approximately balanced since it will be free to abruptly spin when the gears are disengaged. You definitely do not want the scope to yank from your hands and crash into the pier!

On the following page is a pictorial sequence that shows how to disengage the gears. It is as easy as flipping a lever!



1. Grip the Lever Assembly Cover and pull it free to expose the Lever Assembly inside. There are grooves on either side of the cover to assist with your grip.
2. Rotate the Lever 180° to disengage the worm (never force it past its limits). When you rotate the lever, the motor gear-box will tilt and disengage the worm from the worm wheel. **Caution: The axis will spin freely when disengaged.**
3. Rotate the Lever back when balance is complete. Once balance has been completed, *gently* turn the lever and re-engage the worm and worm wheel (shift the axis as needed). Rotate it fully into place and replace the cover.

VERY IMPORTANT: Begin the balance process in Park 3 position so that there is not an abrupt swing of an out of balance scope which can damage the worm wheel teeth!!!

Ok...Let's balance!

1. Be sure that a preliminary coarse balance has been done so that no unexpected swings of the scope take place. Be sure that the clutches are tight on both axes. You will not use the clutches to balance the mount.
2. **R.A. Axis** -- Release the gear mesh in the R.A. axis as described in the pictorial above. While holding onto the counterweight shaft, swing the shaft to a horizontal position either east or west to your convenience.
3. Slide the heavier weights to the top of the shaft and try balancing with just the lower, lighter weight. If you must, slide the weights lower as necessary to balance, however, it is better to add another heavy weight up high.
4. Once you have the balance perfect with the axis horizontal and not moving, then slide the lowest weight slightly further down the shaft so that the axis has a small amount of drift in that direction. You want a little bit of offset...not much.
5. Position the axis horizontally and then gently turn the lever to re-engage the worm and worm wheel. You may need to slightly rotate the axis so that the gears drop into mesh.
6. Once the lever is fully in its locked position, replace the cover and move on to the Dec. axis.
7. **Dec. Axis** -- Release the gear mesh in the Dec. axis as described in the pictorial above. While holding one end of the scope, swing the scope into a horizontal position.
8. Loosen the tube mounting rings or the dovetail saddle locking knobs and position the scope so that it is perfectly balanced and stable in a horizontal position. Remember that the camera should be in its focused position for accuracy.
9. Once you have the balance perfect with the axis horizontal and not moving, then slide the scope slightly toward the camera end so that the axis has a small amount of drift in that direction. You want a little bit of offset...not much.
10. Position the axis horizontally and then gently turn the lever to re-engage the worm and worm wheel. You may need to slightly rotate the axis so that the gears drop into mesh.
11. Once the lever is fully in its locked position, replace the cover and you are finished. Now you can loosen the clutches and reposition the scope into a reference Park position so that you can power up and be oriented.

Altitude and Azimuth Adjustments - Rough polar alignment

It is recommended that you not attach the RAPAS until you have roughly centered Polaris through the site hole.

For rough polar alignment, your goal is to sight the celestial pole when looking through the polar alignment sight hole in the center of the polar axis. You will need to make altitude (up/down) and azimuth (side-to-side) adjustments to the position of the mount.

Before beginning, make sure that the mount is pointing roughly north using the built-in compass, and that your pier or tripod is level using the mount's built-in bubble level. (Refer to note below.)



Remember that magnetic north is not the same as true north and varies both with time and with your location. In the summer of 2011, on the northeast tip of Maine, for example, magnetic north is west of true north by a whopping 18 degrees! On Mauna Kea in Hawaii, by contrast, magnetic north is about 9 1/2 degrees east of true north. Observers along the Mississippi River are lucky and are nearly dead on.

These values change by several arcminutes every year. With experience at a particular site, however, you will soon learn to use the compass to find true north. (You will know just how far off magnetic north is for your location.) In addition, there is an excellent website funded by our U.S. tax dollars that will compute the declination of magnetic north relative to true north for any location that you input. The link is as follows: <http://www.ngdc.noaa.gov/geomag-web/#declination>

Note on Bubble Levels: It is possible to achieve perfect polar alignment without having the pier level, but it is slightly more difficult. With a pier that is not level, each adjustment in azimuth also causes a minor shift in altitude and vice versa. This is why we have included the bubble level on the *Mach1GTO*. However, don't waste time obsessing about having the pier perfectly level. This is, after all, NOT an Alt/Az mount! Devote the time to the actual polar alignment instead. If you are reasonably close to level, you will not be able to notice a difference. Keep in mind that unless you are a serious astrophotographer or imager, "perfect" polar alignment is not critical.

We recommend that you do your rough polar alignment using just the mount at this time (no scope or counterweights), since you will be making major adjustments to the position. The remainder of the equipment: telescope, finder, camera or eyepiece and counterweights will add considerable weight and require more hand effort to make the adjustments. Later, you will do your final polar alignment with the telescope and counterweights attached, but the adjustments will be small.



Steps to take

1. Remove the polar scope cap. If you examine the polar axis assembly, you will see that the center of the R.A. shaft is hollow. Additionally, if you look at the Dec. axis, you will see that it has a sliding cover (the sight-hole / cable access cover). By sliding this cover to the "open" position, you open a sight line through the R.A. axis and out into the sky. For your rough alignment, you will peer through this sight tube and attempt to center Polaris.
2. Azimuth adjustments: To begin, move or turn the entire pier or tripod east or west until the mount is oriented approximately toward the pole (an imaginary line drawn through the hollow shaft). You can take advantage of the azimuth adjustment slots for your rough polar alignment. The compass on the west side of the polar fork base will help you. Also, if you want the mount to be level, check the bubble level again after moving everything. (Remember, mount leveling is

not critical for most observers.)

Starting in 2011, we began shipping *Mach1GTO* mounts with an integrated Precision Adjust Rotating Pier Base and a rear-mounted, Hi-Res Azimuth Adjuster. The adjuster is labelled in the photos below at right. Owners of earlier mounts that have not been fitted with this upgrade should refer to the instructions in an earlier manual. The part (M1RAUP) is also available as an upgrade if you don't have one. Refer to the website for details.

The Precision Adjust Rotating Pier Base does NOT use lock knobs for the Azimuth, so there is no resulting shift. The two plates are precisely machined for a perfect fit with no tilt or shift. Adjustment is precise and absolute. The Azimuth Adjustment Knobs effectively become the azimuth locking devices.

Note: Tension adjustment between the two plates is possible with two tension set screws on the front of the base (photo at right). This tension has been set to the ideal level at the factory. However, should you experience any play or looseness between the two plates, then *slightly* tighten both adjustment set screws evenly. Test and repeat as necessary. *Do not adjust these set screws unless you are absolutely certain that adjustment is required. DO NOT over tighten under any circumstances!*

To make azimuth adjustments, use the two fine azimuth adjuster knobs, one on each side of the mount, to make adjustments. You must back off the opposing azimuth knob in order to move the other knob in that direction. Please refer to the photos below. These photos also illustrate the 13 degrees of azimuth adjustment possible with this mount. Get into the habit at this point, even for rough alignment, of using the following approach to azimuth adjustments:

- Start by backing off the non-adjusting knob by the amount you wish to adjust. Don't just unscrew it willy-nilly! Try to determine how far you will need to move, and only loosen by that amount.
- Turn the adjusting knob until it tightens against the azimuth adjuster block. Note that the Azimuth Adjuster Block remains fixed. Each knob turns the mount as shown by the fat arrows in the top photo above. In the northern hemisphere, the right knob rotates the mount to the west, and the left to the east.
- Repeat as needed, always turning the adjusting knob into a tightened position.

One full turn of the Azimuth Adjuster Knob is approximately 0.70 degrees (42 arc minutes).

Mach1GTO Azimuth Adjustment Range 13 degrees (+/- 6.5 degrees from center)



Azimuth adjusted to the east of north
(Azimuth adjusted to the west of south)



Mount centered in azimuth



Azimuth adjusted to the west of north
(Azimuth adjusted to the east of south)

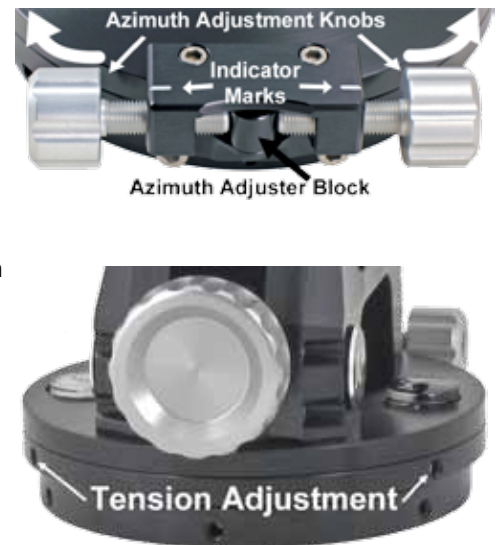

3. **Altitude (latitude) adjustments:** The altitude adjustment mechanism on the *Mach1GTO* has two components. There is a large altitude adjustment knob on the front (north) side of the mount for making the adjustments. The second part is the innovative tool-free altitude locking lever on the west side of the polar fork base. This lever has a spring-loaded, ratchet-type action that allowed us to use a longer handle for leverage than would otherwise have been possible. Pulling the handle out away from the base (pull it to the west) will disengage the handle so that it will turn freely in either direction. Using this feature, you simply ratchet it tight when your altitude is set, or ratchet it loose if you need to make a major adjustment.

The shaft of this locking lever is the pivot axis for the altitude adjustments. Turning the altitude adjuster rotates or pivots the mount, up or down, around this axis. Latitudes below about 46 degrees will always have the total system weight north, or in front of this pivot axis, and will therefore have gravity pulling everything down toward the front. At these latitudes, make your approach to the pole from below so that gravity keeps the adjustment system fully engaged from below.

At latitudes above about 54 degrees, the system weight is behind the altitude pivot axis, so you will want to approach the pole from above. At these higher latitudes, gravity will assist in keeping the adjuster fully engaged from above. At latitudes between about 46 and 54, the mount is pretty well balanced over the altitude pivot. More detail for these latitudes is forthcoming in the section on fine polar alignment starting on page 27.

To start your altitude adjustment, loosen the altitude locking lever. If you have preset your latitude using the scale as suggested on page 11, you do not need to loosen very much because you will not be moving too far. Move the polar axis up or down with the large altitude adjustment knob located in the front of the polar axis assembly.



One turn of the Altitude Adjustment Knob is approximately 1.04 degrees (62 arc minutes).

4. Continue your azimuth and altitude adjustments until you can sight Polaris in the polar alignment sight hole. Try to center it roughly in the sight hole. A very dim red light may help you see enough of the hollow shaft to help you with centering without obscuring Polaris. At this point, you have achieved a rough polar alignment, which may be sufficient for casual visual observations, if you are not planning to slew to target objects with the keypad. When the R.A. motor is engaged (the power is plugged in), it will compensate for the rotation of the earth and keep the target object within the eyepiece field-of-view. Your target object will slowly drift since polar alignment at this stage is only approximate. However, you can make corrections with the N-S-E-W buttons of your keypad controller.

***Mach1GTO* Altitude Adjustment Range**
Zero degrees to 70 degrees



Zero Degrees Latitude

35 Degrees Latitude

70 Degrees Latitude

Fine Polar Alignment

For casual observation, you may skip most of this section and simply start observing. A finder-scope or your lowest power eyepiece may be required to locate objects since GoTo slews with the keypad require good polar alignment for spot-on accuracy. Don't forget to tighten your altitude locking lever and make sure both of your azimuth adjuster knobs are snugged against the azimuth adjusting block. Move the telescope manually or by using the N-S-E-W buttons of the keypad.

The keypad and GTO Servo control box will function as soon as they are plugged in. That means that the R.A. axis will be tracking up to the limits of your polar alignment. However, if you plan to use any of the go-to functions of the *Mach1GTO* or do astrophotography, you must perform a more accurate polar alignment. Some methods, procedures and tips are presented below. You will complete this alignment when your scope and other equipment are mounted.

Methods for fine polar alignment

- **Right-Angle Polar Alignment Scope (RAPAS)** – Using our highly accurate, neck-friendly Right-Angle Polar Alignment Scope will provide all the polar aligning accuracy needed for visual observing. As an imager, if you make the one-time R.A. rear plate adjustment as described in the RAPAS instructions, then you will be able to start imaging immediately after aligning with the RAPAS. Long focal length scopes may benefit from further refinement of polar alignment. This scope is designed for both Northern and Southern Hemispheres.
- **Losmandy Polar Alignment Scope** – Alternatively, the Losmandy polar scope (PASILL4, or the PASILL4-179) models can be used. This scope will also allow you to quickly align your mount on the pole stars; however, it neither has the accuracy nor the ease of use of the RAPAS. The reticle is designed for use in both the Northern and Southern Hemispheres.

If you have a Losmandy PASILL4 or PASILL4-179, please read the instructions sheets that came with it with the following modification: To use the polar scope with your *Mach1GTO*, simply turn the polar scope's reticle housing instead of the R.A. axis as instructed during the final stages of polar alignment. If you started with the reticle properly oriented these will be small movements. DO NOT confuse the reticle housing with the eyepiece, which can also be turned for focusing!

The Polar Alignment Scopes will prove adequate for many users. Users of the GTO computerized mounts will find these polar scopes useful, particularly if your telescope is not orthogonal to the mount (please refer to the keypad manual for a discussion of orthogonality). Even imagers who will refine their alignment beyond the polar scope's resolution will find it a great asset in getting close.

- **GTO Keypad** – Please refer to the instruction manual for the GTO Keypad and read the sections from “Getting Started” through “Alternate Polar Calibration Routines & Tips.” As time goes on, the keypad manuals will be updated. Please refer to the Technical Support section of the website for the most recent documentation. Here are summary descriptions of several techniques for polar alignment from the current Keypad Manual available on the Technical Support page of our website.
 - The Keypad startup routine provides two methods: The North Polar Calibrate and the Two Star Calibrate. These two polar alignment methods, though no longer recommended, were designed for quick and coarse alignment in the field with portable setups. They are for visual observers, not imagers. The Two Star Method is the better of the two as it is less affected by the extremely low resolution in R.A. near the pole and by orthogonality issues.
 - The Daytime Routine (see “Polar Aligning in the Daytime” in the Keypad Manual), is a great trick for daytime setup. It will allow you to “wow” your friends by setting up and finding planets and bright stars in the daytime. In addition, it is the recommended first step in alignment for anyone in the southern hemisphere. Even those in the south who own our polar scope will find it helpful, since it will generally put the rather difficult-to-spot southern stars into the polar scope's field of view.



- The GTO Quick Star Drift Method is for use with a finder scope. By using a finder scope, you are able to remove orthogonality issues from the process, making subsequent alignments much easier.

Using the Daytime Routine, followed by the GTO Quick Star Drift Method, will provide accurate enough polar alignment for extensive imaging. This combination is our recommended procedure for anyone in the southern hemisphere, or anyone who finds their view of the pole obstructed.

- **Computer Software Solutions**

- Polar Align via PEMPro's "Pole Align Wizard" – *PEMPro™* is a software by Ray Gralak and distributed by CCDware. This powerful application not only analyzes and improves the periodic error performance of any mount that is equipped with a CCD camera and compatible camera control software, but also includes "Pole Align Wizard".

"Pole Align Wizard" is one of the best method of accurately polar aligning! It is like traditional drift aligning, but on steroids! It has the advantage of automatically choosing the optimized stars for drift aligning and does not have to worry about star magnitude since the CCD can see dimmer than an eye. Also, it compensates for air refraction and other variables that manual drift aligning cannot. It does require the use of a CCD camera and corresponding camera control software. The Wizard walks you through the alignment process with easy step-by-step instructions. **Note: This and the R.A. Correction Method (on the Technical Support page of our website) are the preferred alignment method when tweaking the RAPAS orthogonality.**

A full *PEMPro™* edition is included with the 1100GTO, 1600GTO and 3600GTO mounts (sorry, not the *Mach1GTO*).

- Other Software – There are many software packages that include aids to polar alignment that can be found through a Google search. Some will work better than others. Do not be fooled into thinking that your alignment is perfect simply because a piece of software told you so. Polar Alignment is, after all, entirely a mechanical issue. Apart from "Pole Align Wizard", we do not have experience with these other software programs and cannot vouch for them or provide support.

- **Star Drift method** – Traditionally, this very time-consuming procedure has been regarded as the most accurate method of polar alignment. However, if you are using the old method of drift alignment that employs stars near the eastern or western horizon, you may encounter problems from atmospheric refraction, which will skew your alignment. To obtain more accurate results, choose stars somewhere near the celestial equator due south or slightly east and west, but not below 45 degrees elevation.

For portable setups, we believe that our GTO Quick Star Drift Method using the Meridian Delay Feature and a Finderscope (found in the keypad documentation as noted above) is a much more practical approach in terms of providing highly accurate alignment and still leaving enough time to actually get some imaging done. A permanent observatory setup where long unguided exposures are taken may still benefit from a final tweaking using the traditional star drift method (as modified by the 45 degree elevation recommendation above) or from a software enhanced variant like the *PEMPro™* Pole Align Wizard that allows a CCD to measure and calculate the drift much faster than can be done at the eyepiece.

- **DRIFT ALIGNMENT – R.A. CORRECTION METHOD** – Please see the Technical Support page of our website for the instructions to this alignment technique. This will provide the highest precision of polar alignment with the least amount of drift within 45 degrees of the zenith (where most imaging is done). **Note: This and the "Pole Align Wizard" are the preferred alignment method when tweaking the RAPAS orthogonality.**

Altitude and Azimuth Adjustments

The mechanics of altitude and azimuth adjustment are relatively straightforward. In the discussion below, we will provide some information and tips that will give you the greatest success with your *Mach1GTO* regardless of the method you choose for determining the amount and direction of each adjustment. We'll leave the choice of method up to you. We list the fine altitude adjustment first because our GTO Quick Star Drift Method begins with altitude. Many texts for the classic star drift method begin with the azimuth adjustments.

When you made your rough alignment earlier, you loosened up the altitude lock-lever, got the mount close, and then tightened it back down to the appropriate tightness. Any minor shifting that might have occurred from locking things down tight was of no consequence since it was a rough procedure. Shifting from the azimuth adjustment system has been eliminated by the Precision Adjust Rotating Base and Hi-Res Azimuth Adjuster. Now you are fine-tuning the alignment, so we want to use small steps and keep things tight.

Fine Altitude Adjustment

It is important that you have the altitude lock lever at the proper tension for your final altitude adjustments. This was described in the earlier section on rough alignment, and is basically just tight enough that any up / down or side-to-side play is removed. We will review this procedure here.

- a) Loosen the Altitude Lock Lever a small amount. You should NOT need to loosen the lever by more than one-half turn.
- b) Grab the end of the counterweight shaft with your left hand and wiggle it up and down to feel the small amount of play or backlash in the system. This is normal with the lever loosened, and is inevitable in an adjustment system that must cover a range of 70 degrees.
- c) Gradually tighten the altitude lock lever up to the point where you no longer feel the play. Do not tighten this lever any more than is necessary to hold the mount firmly in position. The goal is to reach the point where the mount is secure and solid, but the final, small adjustments are still possible.

Even with the lever thus tightened, you will be able to make the necessary minor adjustments in altitude to precisely align the mount. You should feel considerable resistance when making these final altitude adjustments, but they are small adjustments, and should not be too difficult. Making these small adjustments with the lever tightened will not hurt the mount.

One turn of the Altitude Adjustment Knob is approximately 1.04 degrees (62 arcminutes). The knob has sixteen scallops and sixteen raised parts on the gripping surface. This divides the knob into thirty-two equal segments corresponding to about 0.033 degrees or 2 arc-minutes each.

1. Be sure that your azimuth is securely locked in place with both adjuster knobs tight against the block before making fine altitude adjustments.
2. We want to use gravity to our benefit. In the earlier section on rough polar alignment, on page 26, we mentioned differing approaches depending on your latitude. These approaches will be elaborated here.
 - a) If you are below about 46 degrees in latitude, always make your final approach to the pole from below. If you find yourself pointed above the pole, slightly overshoot your downward adjustment so that you can then make a final tweak upward. If you do need to adjust downward, it helps to push down on the end of the counterweight shaft while making the downward adjustment. Then finish with the upward adjustment.
 - b) If you are above about 54 degrees in latitude, make your approach to the pole from above. Your final adjustment should be downward. If you find yourself pointed below the pole, slightly overshoot your upward adjustment so that you can then make a final tweak downward. If you do need to adjust upward, it helps to lift up on the end of the counterweight shaft while making the upward adjustment. Then finish with the downward adjustment.
 - c) If you are in the "balanced range" of latitudes - from about 46 to 54 degrees - start by making sure your counterweight shaft is pointing down and northward. Then move a counterweight down the shaft to bring the system slightly out-of-balance with the counterweight side being heavier. Now adjust as if you were below 46 degrees and when finished, remember to rebalance the system.
 - d) Why the difference in how you approach the pole from higher latitudes? The reason has to do with the concept of gravitational rest position. When you make your final adjustment, you want to leave the mount in its rest position with regard to the altitude adjuster and gravity. This means that if the lock lever were loosened, the mount would not settle into a lower position because of gravity.

Fine Azimuth Adjustment

The earliest production runs of these mounts had azimuth adjusters that were built into the front side of the polar fork. The mount base and the pier adapter with its azimuth adjusting pin were held together by a pair of azimuth locking knobs. Starting in 2011, we began fitting the *Mach1GTO* mounts with a Precision Adjust Rotating Base and Hi-Res Azimuth Adjuster. Users of older mounts who have not purchased the upgrade to this system may wish to consult an older manual for the fine azimuth adjustment procedure since it is a bit different from the one presented here. This assembly is also available as an upgrade for the older mounts. See our website for details.

The *Mach1GTO*'s Precision-Adjust Rotating Base and Hi-Res Azimuth Adjuster assembly makes for easy and accurate polar alignment in your observatory or in the field, and they combine to eliminate issues of adjustment backlash and lock-

down shifting. The Precision Adjust Rotating Base adopts the design used for the 1100GTO, 1600GTO and 3600GTO mounts, as well as the 900 and 1200 Precision Adjust Rotating Pier Adapters. The Hi-Res Azimuth Adjuster has been relocated to the back of the mount where it is extremely convenient to users of the polar scope. The distance from the center of azimuth rotation to the adjuster was nearly doubled correspondingly doubling the resolution of the adjuster knobs.

With the Precision-Adjust Rotating Base and Hi-Res Azimuth Adjuster, it is the azimuth adjuster knobs that actually lock the azimuth in place. (This is the same as for the larger mounts with the Precision-Adjust Rotating Feature.) Your adjustment technique must not leave the knob you have backed off loose. When finished, both knobs must be tight against the azimuth adjuster block to hold the azimuth angle you have set. If you follow our method below, the act of adjustment will leave both adjusters tight against the azimuth adjuster pin.

Adjustment Method: The natural tendency when making azimuth adjustments is to first back one adjuster knob off a significant amount, then make the required azimuth adjustments with the other knob, and then when finished, to tighten the first knob back up against the azimuth block. This can result in a slight shift as the first knob is tightened against the block.

We recommend that you completely abandon this approach for all of your azimuth adjustment. Instead, start with both knobs tightened against the azimuth adjuster block. Then, back off the first knob **only by the small amount of the adjustment you plan to make**. Use the scallops on the knob and the indicator marks on the azimuth adjuster body as reference points to mark your starting and ending points.

One full turn of either Azimuth Adjuster Knob is roughly 0.7 degrees or 42 arcminutes. Each knob has seven scallops and seven raised parts on the gripping surface. This divides the knob into fourteen equal segments corresponding to about 0.05 degrees or 3 arc-minutes each.

Finally, make the actual adjustment by tightening the other knob against the slightly loosened knob thereby making the tiny adjustment you required and eliminating any “lock-down” shift because everything is already tight when you are finished. By using the markings on the knobs, you can easily undo any errors or estimate the magnitude of your next adjustment.

Finally, you will note that the Azimuth Adjuster Knobs have socket cap screws in each end. *These are **NOT** provided to allow extreme tightening of the knobs against the block! Never tighten the knobs beyond hand tight or you may damage the components.* The purpose is to provide even finer resolution for your final small azimuth micro-adjustments. By using hex keys, you can make much smaller incremental moves than is possible with just fingers on the knobs.

Final Note on Altitude and Azimuth Adjustments: Some people love to “tweak” their alignment. Tweaking the azimuth should no longer pose any issues since the Precision Adjust Rotating Base and Hi-Res Azimuth Adjuster do NOT introduce any shifting into the process. If you do make a final altitude tweak, however, DO NOT loosen or further tighten the altitude lock lever. Resist the temptation and leave the altitude lock lever alone!

Using Software to Improve Pointing Accuracy

Software solutions are available today that will help to compensate for orthogonal problems as well as other idiosyncrasies of your telescope, mount and optics. These programs analyze and compensate for these problems, resulting in improved telescope pointing performance.

- Astro-Physics Command Center (APCC), Pro version with pointing and tracking model, www.astro-physics.com
- MaxPoint™ Modeling Software from Diffraction Limited, www.cyanogen.com
- TPoint™ Modeling Software from Software Bisque, www.bisque.com

MACH1GTO AUTO-ADJUSTING GEARBOX - NO MORE WORM MESHING!

The good news is that the *Mach1GTO* is always in mesh, thanks to the Auto-Adjusting Motor Gearboxes! The *Mach1GTO* mount represents a new era in the ease of gearbox adjustment. Our new design eliminates the need for gear mesh adjusting...it has become automatic. Spring pressure holds the worm and worm wheel in perfect mesh at all times.

The only adjustment that may ever need to be made is to re-set a backstop...and that is rarely needed if ever.

- First if you think that there is a worm gear mesh issue, you are probably wrong. If you think there is backlash, it is almost certainly from a different source, so look elsewhere first.
 - Check the mesh of the spur gear reduction set. If this seems loose, contact Astro-Physics for further help.
 - Check that the entire motor/gearbox is securely fastened to the axis housing. There should be a very small amount of front-to-back rocking that is possible due to the spring loading mechanism, but there should be no discernible side-to-side movement. If you feel side-to-side play, contact Astro-Physics
- **IMPORTANT!** Do the following with the mount powered ON. It should be UNPARKED and tracking should be STOPPED. If you need to rotate the gear in order to access the second screw, use direction buttons at 12X or 64X.
 - Check that the worm's spur gear is securely attached to the worm shaft. The 2 screws must be tight. (Be careful, however! They are small screws, not automotive lug nuts!)

Checking and Adjusting the Gearbox Backstops in R.A. and Dec.

This is a very easy and quick process. It is also a process that you should almost never need to do. Many mounts will go several years or longer without the need to tweak this backstop. Adjusting this backstop is about the only way that you can actually mess up your gear mesh. So, approach with caution. (Tool needed: 5/64" hex key)

1. **Put the mount into a Park 3 position.** This is important to ensure that there is not uneven pressure on the gears due to an out of balance load. Be sure that the mount is powered off. Park 3 is counterweight shaft down and scope in line with the R.A. axis, pointing toward the pole.
2. **Remove the Lever Assembly Cover.** Grip the cover and pull it straight out.
3. Make sure the lever is in its normal position - snapped in place, parallel to the respective axis.
4. **Loosen the Lever Assembly screws.** Using a 5/64" or 7/64" hex key, loosen the two screws (#1 in the illustration) so that the assembly is freed to move. This should require less than one turn of each screw.
5. **Apply a slight pressure to the Lever Assembly.** Using your index finger and thumb, apply a very gentle pinching pressure to shift the assembly towards your thumb (it only needs to touch). This sets the proper backstop position. Do Not push on the gearbox itself, as that would cause the box to pivot out of mesh and give a bad adjustment.
6. **Tighten the screws.** While maintaining the slight pinching pressure, snug and then tighten both screws. Do Not Overtighten.
7. **Replace the Lever Cover.** Replace the cover and you are finished. It is that simple!
8. **Repeat with the other axis.** Repeat the process with the other axis, if necessary.



SOME IMPORTANT NOTES

- **When using Mounts with Auto-Adjust Motor Gearboxes:**
 - **Use the clutches when repositioning the mount!** This is a safer practice than using the gearbox disengagement lever in order to ensure that the gear teeth are not damaged by accident. Refer to your manual for clutch operation.
 - **Begin your balance procedure in Park 3 position (pointing to the pole).** This will ensure that an out of balance scope does not have a sudden, wild swing that could damage the scope, the mount or you!
 - **Be sure that the Gearbox engage/disengage lever is fully disengaged and that the worm is fully separated from the worm wheel when balancing the mount (or moving the mount when repositioning)!** It is important not to damage the tops of the gears by bumping the worm and worm wheel teeth!
- **Be careful not to twist and inadvertently damage internal cables.** It is important to remember not to twist and damage internal cables by over-rotating the axes. If the axes are rotated when setting up or performing mount maintenance, you will need to undo the axis rotation to return cables to their normal position. Internal cables should not be pulled tight; rather, they should be left slack and free to move.
- **Be sure that all fasteners on the mount and scope are tight.** You do not want to have to catch a falling scope or see it sitting unexpectedly on the concrete!
- **Computer and Keypad use together.** If you are using a computer for primary mount control, but wish to have the Keypad connected for convenience while at an eyepiece, then set the Keypad to AutoConnect: EXT so that the computer will initialize the mount, not the Keypad.
- **Always Initialize and park the mount using the same device.** If you initialize with the Keypad, then park with the Keypad...if you initialize with the computer, then park with the computer.
- **When using third-party software, park the mount with APCC or the AP V2 driver rather than parking from the OEM programs.** It is always better to park the mount using APCC or the AP V2 driver to ensure safety and proper parking.
- **Unpark from Last Parked.** If the mount is being re-started from a previous night, as in a permanent observatory or at a week-long star party, then unpark from Last Parked (assuming that the scope has not been repositioned manually by hand via the clutches since it was last parked).
- **Unpark from a defined park position.** If your equipment is being set up afresh for a night's observing, then place the scope in a defined park position and have it unpark from that specific position. If it is to remain set up for the next night, then park it to your position of choice and resume from Last Parked the next night.
- **GTOCP4 Control Box will auto-park mount when powered off.** The GTOCP4 control box will auto-park the mount in place when the power is turned off or is interrupted. Nevertheless, we do recommend parking the mount to a convenient park position when finishing the evening's viewing (and leaving the mount set up for another night).
- **Use the mount with its own power supply.** For best performance the mount should have its own power supply. This is especially true when imaging.
- **Reference the Astro-Physics Technical Support page of the website.** There is a wealth of information on the Technical Support page that can often answer the questions that you have, as well as provide in-depth understanding and fixes. All the latest versions of the manuals can be found on the page.
- **Remember that the answer to most questions can be found in the supplied manuals or on the website.** Please reference these manuals or the website Technical Support before calling Astro-Physics. If you cannot find the answer, then the Technical Support team is ready to help.
- **Outdoor Storage** – If you have a mount that is left outside for extended periods covered by a tarp or scope cover, then it is highly recommended to remove the GTOCP4 and Keypad and take them inside to a safer environment. Tarps and covers cause significant moisture build up from condensation unless steps are taken to mediate the problem. Often low wattage light bulbs or fans are used to reduce condensation.

MOUNT CARE, CLEANING AND MAINTENANCE

Like any fine piece of equipment, your mount's longevity and performance are directly correlated with the quality of the care that you give it. Handle it with respect, keep it as clean and dry as is practical, and perform a few minor maintenance tasks, and your *Mach1GTO* will give you many years of trouble free service.

Care

Although we build it to be rugged enough for field use, your *Mach1GTO* is a precision instrument with very accurate worm and wheel adjustments. Please be careful if you place the mount on a flat surface, i.e. the ground or trunk of your car. The gear alignment may be affected if the R.A. and Dec. Motor / Gear Box assemblies sustain undue lateral force. This is true of any fine instrument. We suggest that you transport and store the mount in a case or in a well-padded box. ALWAYS disassemble the mount before moving it or transporting it. More damage can be done in a few careless seconds in transit than in many hours of normal operation.

Try to keep your mount protected from dust and moisture when not in use. In warm, humid weather, be aware of the dew that may have formed on the mount while in the field and allow the mount to dry out before packing it away for storage once you get home. On the other hand, if it is cold and dry outside, keep the mount packed up when you bring it into the house until it reaches room temperature to avoid "fogging it up." (The same advice applies to telescopes, eyepieces and other equipment in your Astro-arsenal.)

Cleaning and Touch-up

Wipe your mount clean with a soft dry cloth. If needed, you can use a damp cloth or a cloth that has been sprayed with a mild, non-abrasive cleaner (window or all purpose cleaner – no bleach). Do not spray cleaners directly onto your mount. If you use a cleaning product, follow with a damp cloth to remove the chemicals from the mount.

The painted surfaces of your mount may end up with scuff marks from repeated transport and assembly / disassembly. Most of the time, these marks can be removed with a product like *Color Back™* by *Turtlewax™* (automotive product). Simply apply with a paper towel and buff out the mark. If your paint becomes chipped, touch-up kits are available for purchase – please call us. *NOTE: Paint touch-up kits can only be sold to U.S. customers due to regulations governing shipment of hazardous materials.*

Routine Mount Maintenance

Under normal operating conditions, minimal maintenance is required. If the R.A. and Dec. axes are attached together for a long time in outside conditions (i.e. in a permanent observatory) then the mating surfaces should be lightly oiled or greased – if you expect to get them apart again after 10 years.

Jostling and vibrations associated with transport to and from observing sites has had the effect of causing screws and fasteners to work their way loose over time. We have worked very hard in both the design and assembly of our mounts to alleviate this problem, but it is still a good idea to periodically (once or twice a year) inspect and if necessary re-tighten any easily accessible fasteners. Additional maintenance information can be found below in the troubleshooting section and in the Technical Support Section of our Web site.

Worm Wheel Maintenance

Using the entire worm wheel ensures even wear and extended life. Under normal use the mount moves back and forth using only one half of the worm wheel...the other half is not used.

Here's what to do: Send the mount to Park 1, unlock the clutches and push the mount to Park 4. Lock the clutches and then power cycle the mount (power off and then on). Tell the mount to resume from Park 4. The mount will then be using the other half of the worm wheel.

Note that it will be necessary to have the Keypad set to AutoConnect=NO (if initializing with the Keypad) or to set the AP V2 driver / APCC (if initializing from the computer) to Unpark from Park 4. Once this operation is done remember to reset to Unpark from Last Parked.

Do it twice a year...that should be enough.

TROUBLESHOOTING, TIPS AND SUPPORT

Troubleshooting and Tips

Additional troubleshooting questions are in the GTO Keypad or GTO Servo System manuals. Some of the issues discussed in these manuals relate to mount communication issues whether you use the keypad or control the mount with a planetarium program or *PulseGuide*™. Please refer to them.

The Declination (or R.A.) axis does not turn freely, even with the clutch knobs fully loosened.

The design of the clutches is such that spring loaded tips always maintain some friction against the worm wheel. Consequently, the axes will never spin freely. Back the clutch knobs off by at least two or three full turns to more fully disengage the clutches. There will always be some friction. The *Mach1GTO* clutches can be fully tightened without worry.

For polar alignment, I am using declination drift technique with stars on east & south. Now, I do not see any drifts in declination on both sides (E & S), so the mount “should be” properly aligned. However, I still have small drift in R.A. which looks like the R.A. motor is a bit faster than earth rotation. This drift is something like 1.5 arcsecond during 1 minute or so and is accumulated over time, so it doesn’t look like periodic error.

The sidereal tracking rate is exact in the mount (it is crystal controlled and checked here for accuracy). However, the stars do not move at exactly the sidereal rate everywhere in the sky. The only place they move at that rate is straight overhead. As soon as you depart from that point in the sky, the stars will be moving more slowly, especially as you approach the horizons. Thus, it looks like the mount is moving slightly faster than the sidereal rate. Just because you have done a classic drift alignment, does not mean that the stars will now be moving at the sidereal rate everywhere in the sky.

In order to increase the area of sky from the zenith that will give you fairly good tracking, you will need to offset the polar axis by a small amount. The amount will depend on what your latitude is. The other approach is to vary the tracking rate for different parts of the sky. Ray Gralak’s *PulseGuide* will allow you to dial in an exact tracking rate for any part of the sky.

Initially, the mount was working fine. Then, suddenly the mount stopped tracking altogether!

Chances are that the motor was turning properly and driving the worm gear, but that your clutches might have been loose and therefore the scope was not following the motion of the worm gear. The fact that the high slew rate did move the scope does not change this, because Roland has seen this himself where the tracking rate did not overcome the slipping clutches but the slew rate did.

If you are unsure of the motion of the motor, just remove the gearbox cover plate and look inside. You will see the motor turning. Sometimes when you have the clutches loosely engaged and the counterweights are somewhat out of balance, being heavy in the east, then the clutches might slip at the slow sidereal rate.

In any case, just to set your mind at ease, simply remove the gearbox cover next time something like this happens and look at the motor shaft. If the motor is not turning, you will have some kind of electrical problem. If it is turning, then it is mechanical.

My GTOCP4 Control Box does not appear to be working properly. Can I use the control box from my other Astro-Physics mount with my *Mach1GTO*?

The answer depends on the model of your other Astro-Physics mount. The GTOCP4 from your *Mach1GTO* can be interchanged with the GTOCP4 or GTOCP3 from 1100GTO or 1600GTO mounts and the GTOCP2 or GTOCP3 from most 900GTO or 1200GTO mounts. The interchange works in either direction...the mounts can be “borrowers or lenders”. (Be careful if exchanging with 900GTO and 1200GTO mounts from 2001 and earlier. Motor chatter or buzzing may result. If this happens, do not continue to use the older control box.)

A GTOCP1 cannot be used as it does not have the correct servo cable connection. DO NOT use the control box from a 400GTO, a 600EGTO, a 3600GTO or from a mount purchased from an OEM partner that uses our GTO system. These mounts employ different gearing in their servo drives and therefore use different parameters in the servo controller.

As a final note, if you “borrow” another control box for your mount, you must disable the PEM since the PE curve in the borrowed box will be for a different mount. You can always record a new PEM data set if you wish, and there is no reason to preserve the PEM data set in the borrowed box since it will no longer be valid on its original mount anyway. Any time

that you use a different control box on a mount, the PEM data becomes out of phase and will need to be redone. This applies to both the borrowing mount and the lending mount. It is something to consider before trading control boxes, especially if you have achieved a particularly good PEM result with the mount that is to be the “lender.” Visual observers may simply turn off the PEM.

The declination axis does not appear to be moving properly. How can I check it?

Please refer to the section entitled: “Declination Axis Backlash Tests,” which explains how to use *PulseGuide*™ and *MaxImDL*™ software to characterize your mount’s performance. It is found in Appendix A of this manual.

Additional Support

Remember that additional information on the servo drive system is now found in the separate Astro-Physics GTO Servo Motor Drive System manual.

For additional information regarding the *Mach1GTO*, refer to the Technical Support Section of our website. We also encourage you to participate in the ap-gto user group. The members of this group are very knowledgeable about the operation of their mounts, CCD imaging and other related issues. The staff of Astro-Physics also participates and you will find a wealth of information in the archives. To find the group, link from User Groups in our website’s sidebar.

If any problems occur, please don’t hesitate to contact Astro-Physics for assistance.

We encourage you to submit your technical support questions directly to Astro-Physics by phone or e-mail: support@astro-physics.com.

We may add additional troubleshooting tips to future versions of this manual or in a separate technical document. In such an instance, we would add this information to the Technical Support section of our website as well.

ASTRO-PHYSICS, INC
11250 Forest Hills Road
Machesney Park, IL 61115
Telephone: (815)-282-1513
Fax: (815)-282-9847
support@astro-physics.com
www.astro-physics.com

APPENDIX A: DECLINATION AXIS BACKLASH TESTS

PulseGuide™

PulseGuide™ is a free software program, developed by Ray Gralak, to provide keypad-like functionality using a computer. It offers the additional feature of a Dec. axis backlash test. You can download it through a link from the AP website.

Once you have started the PulseGuide™ application and have connected to the mount, go to the "PEM/other" tab and click the "Backlash Tests" button to bring up three tests suggested by Roland Christen to test the performance of your declination axis. Roland posted some tests that you can run on your AP mount to see if it has a potential problem with Dec. movement.

IMPORTANT: Before running tests 1 and 2 set the mount's backlash to 0. Also while performing the tests do not try to auto-guide.

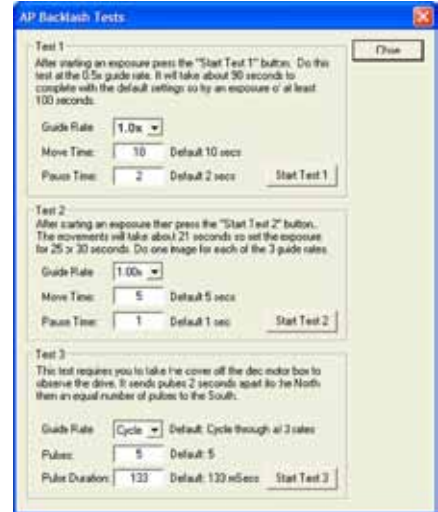

Dec. Backlash Test 1

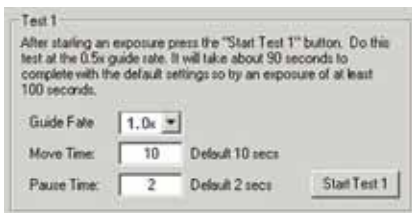

Before starting Test 1 set up your camera control program (e.g. *MaxImDL™*, *CCDOps™*, etc.) to take a 100 second exposure (but do not autoguide). You can also set up an auto-dark exposure, but make sure that you start the test when the camera control software is exposing the light image.

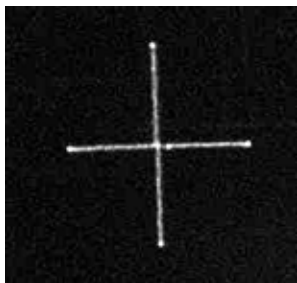

Once you start the exposure press the Start Test 1 button. With the default settings (recommended) the entire procedure will take about 90 seconds.

Test 1 will move the scope in this manner: East - pause - West - pause - East to center - North - pause - South - pause - North to center.

The stars in the resulting exposure should look something like the image to the right. The scale might be different but you should see what looks like many plus signs in the image.

If you take the image near Dec=0 the height and width will be about the same. Although not shown in this particular image the East and West points will be slightly brighter than the North/South points. This will make it easy for Roland to establish the orientation of the camera.

Dec. Backlash Test 2

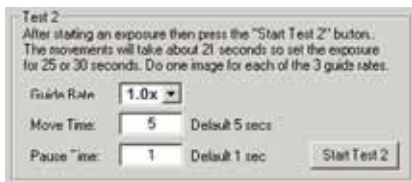

You will run Test 2 three times, once for each of the guide rates. Before starting this test set up your camera control program (e.g. *MaxImDL™*, *CCDOps™*, etc.) to do a 25 second exposure but do not try to autoguide. You can also set up an auto-dark exposure, but make sure that you start the test when the camera control software is exposing the light image.

Start by setting the Guide Rate to 1x. Once you start the exposure press the Start Test 2 button. With the default setting (recommended) the entire procedure will take about 16 seconds.

1.0x



Although the scale might be different, the stars in the resulting exposure should look something like the image shown.

0.25x



For reference the actual movement in Test 2 is: North+West - South+West - West only (the pause setting) - North+West.

Now you will need to repeat the tests at 0.50x and 0.25x. The star patterns will look similar but smaller because the movement rate is slower. Here are two examples taken with a Traveler:

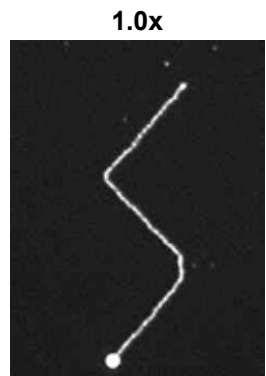

After Running Tests 1 and 2

If you see star patterns different from the above images then crop a bright star in each of the four images and save them as a high-quality JPEG. Please make sure to “stretch” each image appropriately so that it is not too dim or overexposed. If you do not know how to stretch and create a JPEG then save the cropped image in FITS format.

Then send the 4 files (preferably zipped to save bandwidth) to Roland at: chris1011@aol.com.

After submitting these tests, AP will advise you if anything appears anomalous and if so what can be done about it.

Dec. Backlash Test 3

This test moves the declination motor at regular intervals to check that the gears move properly.

To do this test you will need to remove the cover from the declination motor housing (contact Astro-Physics for directions if you need).

The Guide Rate combo-box has 4 choices: 0.25x, 0.50x, 1.00x, and Cycle. You can choose a specific rate or Cycle to have *PulseGuide*™ repeat the test at each rate.

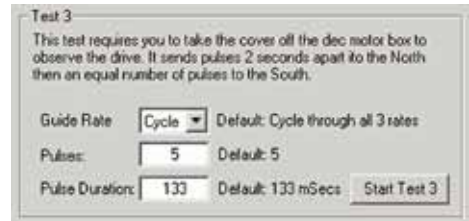

While watching the uncovered declination gears click the Start Test 3 button. *PulseGuide*™ will send 5 pulses spaced 2 seconds apart (or however many you entered in the Pulses edit box). Each pulse will be of the same duration – that which you enter in the Pulse Duration edit box. The default is 133 milliseconds. Watch carefully to make sure the pulses look evenly timed and that the fastest moving gear moves equally each time.

Once all pulses have been sent in one direction, an equal number of pulses are sent in the reverse direction. It is normal on reversal of direction that there is a slight delay in movement because of backlash. If this happens you may wish to increase the pulse count. If you see erratic movement please contact Astro-Physics for instructions.

MaxImDL™

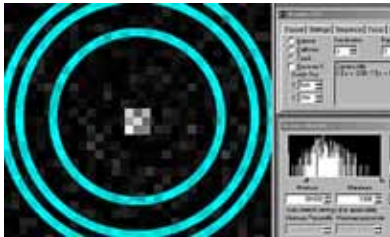

Step 1

Acquire a reasonably bright guide star and begin guiding in R.A. only - turn off Dec. guiding. Use a 1 second or faster refresh rate so you can see the motion of the guide star as you begin to move it around. Magnify the screen to 1600x and place the cursor in the middle as shown. Check to make sure that the mount is guiding adequately in R.A. and that the guide star is not bouncing around due to poor seeing. Best results will be achieved when the R.A. guiding is 0.5 pixels average in R.A.

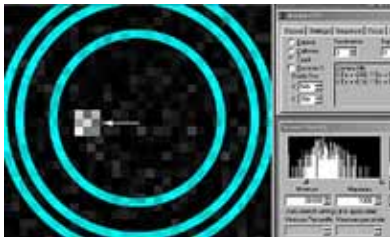

Step 2

Put the keypad button rate at 1.0x. Press the keypad North button until the guide star has moved approximately 6 pixels from the center. Now press the South button in very short pulses and note which direction the star moves. It should move back toward the middle after a few button presses. It might move slightly up or down, or it might continue to move further away from the middle, or any combination. Please note exactly how far, and in which direction, the guide star moves (pixel position is displayed in the guide box at right in Maxim).

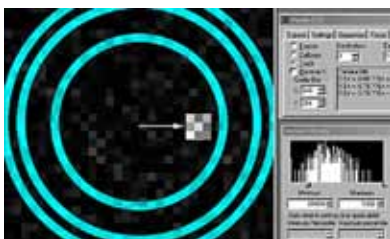

Step 3

Press the South keypad button until the star has moved 6 pixels off the center in the opposite direction. Repeat Step 2 and note exactly the motion of the guide star as you move it with the pulsed motion at 1.0x.

You may wish to enable Track Log to record the numbers for further study. Please note on the log what you did at what time so the results will be useful later.

APPENDIX B: MOUNTING PLATE FASTENER CHART

A-P Part #	Description	Ships with:
FP1500	15" Flat Plate	(4) 1/4-20 x 5/8" SHCS [for mounting to 400, 900 or Mach1GTO] (4) M6-1.0 x 20mm SHCS [for mounting to 600E] (4) 1/4-20 x 3/4" SHCS [for mounting to 1100GTO, 1200, & 1600GTO]
FP1800	18" Flat Plate	(6) 1/4-20 x 1" FHSCS [for mounting to 900, 1100GTO, 1200 or 1600GTO] (4) 1/4-20 x 1-1/4" FHSCS [Mach1GTO]
DOVE15	15" Dovetail Saddle Plate for use with SB1500	(4) 1/4-20 x 1/2" FHSCS [for mounting to 400 or Mach1GTO] (4) M6-1.0 x 16mm FHSCS [for mounting to 600E] (4) 1/4-20 x 5/8" FHSCS [for mounting to 900, 1100GTO, 1200 or 1600GTO] (4) 10-32 x 3/4" SHCS [for mounting as Accessory Plate onto A-P rings]
DOVELM2	8.5" Dovetail Saddle Plate for Losmandy D Series Plates for 400, 600E, Mach1, 900 and 1100 Mounts	(4) 1/4-20 x 5/8" SHCS [for mounting 400 or Mach1GTO] (4) M6-1.0 x 20mm SHCS [for mounting 600E] (4) 1/4-20 x 3/4" SHCS [for mounting to 900, 1100GTO, 1200 or 1600GTO] ** [or to attach to SBD13SS or SBD16SS]
DOVEDV10	10" Dovetail Dual Saddle Plate for Losmandy D-Style and Vixen V-Style Dovetail Plates for 400, 600E, Mach1, 900 and 1100 Mounts	(4) 1/4-20 x 5/8" SHCS [for mounting 400, Mach1GTO, 900GTO or 1100GTO] (4) M6-1.0 x 20mm SHCS [for mounting 600E]
DOVELM162	16" Dovetail Saddle Plate for Losmandy D Series Plate for 900, 1200, Mach1GTO. Also for 3600GTO w/ SB3622 or SB3627 Can also be mounted on AP ring tops with blocks	(6) 1/4-20 x 1" SHCS [for mounting to 900, 1100GTO, 1200, 1600GTO or Mach1GTO (M1 uses 4), or to attach to SBD13SS or SBD16SS] (1) 1/4-20 x 3/4" FHSCS [opt. 900, 1100, 1200 or 1600 for end positions] (4) 1/4-20 x 3/4" SHCS [for SB3622 in side-by-side configuration and for attachment to blocks for ring-top mounting]
900RP	15" Ribbed Plate for 900 or Mach1GTO	(6) 1/4-20 x 1" FHSCS [for mounting to 900 or 1100GTO] (4) 1/4-20 x 1-1/4" FHSCS [for mounting Mach1GTO]
1200RP15	15" Ribbed Plate for 1200 and 1600	(6) 1/4-20 x 3/4" SHCS [for mounting to 1200 or 1600GTO]
1200RP	24" Ribbed Plate for 1200 and 1600	(6) 1/4-20 x 1" SHCS [for mounting to 1200 or 1600GTO]
Q4047	900/Mach1GTO Adapter for use with DOVE08	(6) 1/4-20 x 5/8" FHSCS [for mounting to 900 or 1100GTO] (4) 1/4-20 x 1" FHSCS [for mounting to Mach1GTO]
SB1500	15" Dovetail Plate for DOVE15 Saddle Plate	(2) 1/4-20 x 1/2" SHCS (2) Acorn Nuts (2) 1/4-20 Nuts (2) 1/4-20 x 3/8" SHCS (1) 10-32 x 5/8" FHSCS (1) 10-32 Nut
SBV15	15" Dovetail Plate for the Vixen V-Style Dovetail Saddle Plate, Wide Profile	(2) 1/4-20 x 1/2" SHCS [for center hole in rings] (4) 1/4-20 x 5/8" FHSCS [for attaching directly to AP rings] (1) 1/4-20 x 3/8" SHCS [for Safety Stop]
SBD12	12" Dovetail Plate for the Losmandy D-Style Dovetail Saddle Plates	(4) 1/4-20 x 1" low profile SHCS [for attaching the SBDAPB or LMAPBLOCKS] (4) 1/4-20 x 1-1/4" FHSCS [for attaching directly to AP Rings] (2) 1/4-20 x 1/2" SHCS [for center hole in rings] (4) 1/4-20 x 1/2" low profile SHCS (3) 1/4-20 x 3/8" SHCS [2 for Stowaway - 1 for Safety Stop] (2) 1/4-20 x 7/8" SHCS [Stowaway with SB0550 as spacer]
SBD16	16" x 5" Wide Sliding Bar for the Losmandy D-Style Dovetail Saddle Plates	(4) 1/4-20 x 3/4" SHCS [for attaching the SBDAPB or LMAPBLOCKS] (4) 1/4-20 x 1-1/4" FHSCS [for attaching directly to AP Rings] (1) 1/4-20 x 3/8" SHCS [for Safety Stop]
SBDAPB	AP Riser / Spacer Blocks	(4) #10-32 x 1/2" SHCS [for attaching to mounting ring tops] (2) 1/4-20 x 1/2" SHCS
SBDTB	Adapter Blocks for large Taks - Mewlon, BRC & FRC	(4) M10 x 20 mm SHCS [for attaching to SBD16]
SBD13SS OR SBD16SS	13" or 16" Side-by-side Dovetail Plate for Losmandy D-Series Dovetail Saddle Plates	(2) 1/4-20 x 3/8" SHCS [for Safety Stops -required at both ends]
SBD2V	12" Losmandy D-Style Male to Vixen V-Style Female Adapter / Sliding Bar	(1) 1/4-20 x 1/4" low profile SHCS [to replace Safety Stop on V plate] (1) 1/4-20 x 1/4" SHCS [Safety Stop for SBD2V]
LT2APM	Losmandy Tripod to Astro-Physics Mount Adapter Plate	(3) 5/16-18 x 5/8" SHCS (4) 1/4-20 x 5/8" SHCS (4) 1/4-20 x 1" SHCS (3) 3/8-16 x 3/4" SHCS
CBAPT, TRAYSB & TRAYSB1	Control Box Adapter, Bi-Level Support Bar & Single Level Support Bar	(1) 1/4-20 x 3/4" FHSCS (1) 1/4-20 x 1" FHSCS (1) 5/16-18 x 1" BHSCS (2) 5/16-18 x 3/4" BHSCS
DOVEPW	16.5" Dovetail Saddle for Planewave 7.652" dovetail on AP 1200, 1600GTO and 3600GTO	(6) 3/8-16 x 1" SHCS (6) 1/4-20 x 1" SHCS
SBPW23	23" P-Style Dovetail Plate for DOVEPW	(2) 3/8-16 x 1/2" low profile SHCS (4) 1/4-20 x 5/8" SHCS
DOVE3622	22" Dovetail Saddle Plate for 3600GTO	(6) 3/8-16 x 1" SHCS (4) 3/8-16 x 1-1/2" SHCS
SB3622 OR SB3627	Dovetail Dovetail Plate for DOVE3622	(2) 3/8-16 x 1/2" low profile SHCS (4) 1/4-20 x 7/8" SHCS for lock-down

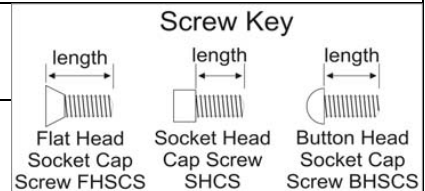

** DOVELM2 may also be attached to 900 mount with (1) 1/4-20 x 5/8" FHSCS and (1) 1/4-20 x 3/4" SHCS